

50th-anniversary edition for the REFLEX XTR² simulator

Das Ugly Stik

Design: *Phil Kraft* Enhancement: *George Walker* Kit: *Jim Jensen*

Phil Kraft pioneered proportional radio control and in 1964 designed a simple and robust test-bed that later became known as Das Ugly Stik. In 1966 he published plans drawn by his friend *George Walker* in the GRID LEAKS magazine, and his friend *Jim Jensen* brought out a kit. Both the design and the kit quickly became famous, and many model fliers had one or more of the originals or the numerous variants coming up soon and until today.

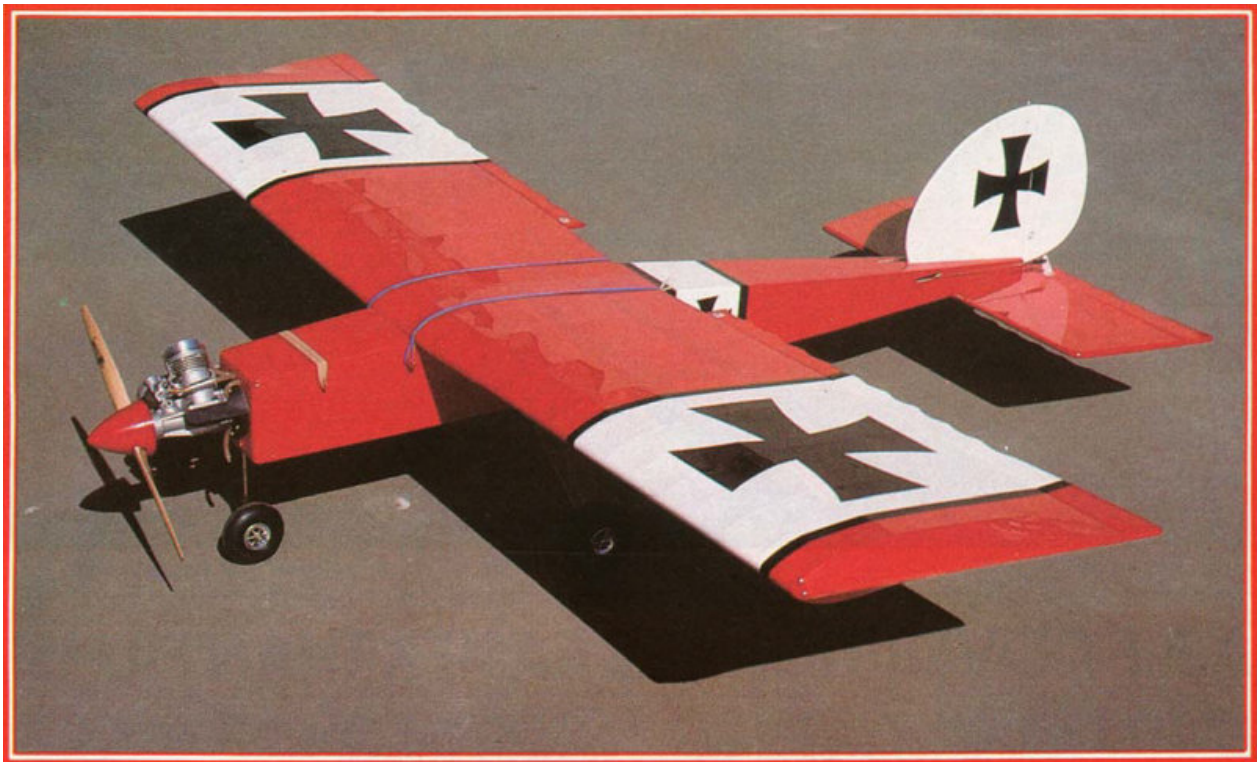

In those early days, models and equipment were quite expensive so both had to be simple just to be affordable. Now the Stik wasn't only that but also very versatile. The same one model could be used as a basic trainer and then converted to an intermediate and full aerobatic trainer, only by adding engine power and control throw. And it was so good-natured and rugged that it really had a chance to survive its pilot's learning curve from the beginnings to the last stage. Then, it was a sport airplane that could be recklessly knocked around – perhaps the first fun-fly model.

Now let me explain what this paper is meant for:

The model was quite appealing to me, and in 2006 I thought it's a nice idea to revive it "virtually" (in a simulator), so I could see and feel how it flies – for the first time ever. A "hands-on" experience, even in a simulator, is far better than only reading about a model airplane or looking at plans and pictures of it. This "living history" ploy worked out for me, but then again for other people as well. Seasoned model fliers enjoyed having the old look and feel again as well as younger modelers came to know and appreciate this true classic and its amazing characteristics.

Nevertheless, only experiencing the model by flying it is not enough either. It's good to know how far the simulator model is true to the original and what the limitations are. That's why the first chapter simply describes how the simulator models of the Jensen kit version have been built, painted and set up. The next two chapters describe fictitious variants with a rotary engine and an electric drive, respectively. They are followed by a chapter about an original Das Ugly Stik version conforming to the plan in the 1966 GRID LEAKS publication, a chapter about the two 1966 prototypes, and a chapter about the unpublished, "really original" 1964 square, or boxy test-bed version.

Over the years, a good deal of interesting background information, plans, and history accumulated. Eventually, that was even supplemented by first-hand knowledge and original material by *George Walker*, who was something like the originator of Das Ugly Stik as we know it. On this occasion, the chapters about the simulator models and the chapter about the different plans and the model's history, which had been separate PDF files, have been joined and thoroughly updated, making this paper.

In 2006, I called the simulator model a 40th-anniversary edition. By now, in 2016, it is called a 50th-anniversary edition, also because it has been revised a lot. It's still important as a (virtually) "living" model since the REFLEX XTR² model flight simulator is still available (see section Sources below). Several model fliers own this simulator and the model is downloaded frequently. Moreover, it is important as a virtual representation of the original and its variants. There are no known color photos of the original models (the picture above is from the 1985 RCM article) but the simulator model is a way to get some ex-post by screenshots from the simulator, what looks pretty photo-realistic. Even flight videos have been made in the simulator, as supplements to the actual maiden-flight movie by *George Walker* (links to them at YouTube in the following chapters).

Anyway, the last chapter, about the history of Das Ugly Stik, is now the most important, or at least the largest one. It has been referenced (linked) in the Internet and has become a download "bestseller" in the last few years. That's why it has been updated most, and joined with the descriptions of the simulator models, which are excellent illustrations of the original historic models after all.

Credits

Where does all my wisdom come from? Well, credits are due to all those who published something about the Stik in the Web, may it be information, data, plans, pictures, or stories. There are even persons who directly contributed lore, knowledge, and material. Of course, you'll have to blame me, the author of this paper, for any errors, flaws, or misunderstandings.

In 2006, *Eric Wildermuth* from Brisbane, Australia, kindly provided scanned images of his copy of the 1966 Grid Leaks magazine and of the 1985 American Radio Control Modeler magazine. He had also valuable information from his rich experience building and flying several Ugly Stiks. Later, in 2009, he found the ACE advertisement mentioning Ugly Stik's derivation from a "Square Stik". He made this project possible in the first place. Thank you very much!

Only ten years later, in 2016, *George Walker* found this paper in the Web and contacted me. Fifty years ago, he had the idea to turn a mere expendable "Box-Fli" into Das Ugly Stik, built a prototype, and drew the plans. He remembers several historic details, and he still has original plans and other material. That allowed to correct some flaws in this paper and the simulator models, to finally complete the model's history, and to make this paper a worthy presentation of this history. At least I hope so. Thank you so much!

Other, "passive" contributions are given credit in the respective "Sources" sections below.

Sources

The original Jensen kit is out of production for a long time, but the plans belonging to it were still available from the RCM Plans service, which is now defunct. Today they are available for download from the [Outerzone](#) vintage plans website, and they are even scans of *George Walker's* original.

The [AMA biography of Phil Kraft](#) says the plans were first published in 1965 by the R/C Modeler (RCM) magazine. But that has to be a typographical error or a mistake because the magazine only brushed-up and re-published the Jensen kit plans with building instructions, along with the original 1966 article's text, in 1985.

The defunct RCM Plans Web site still listed old RCM articles as well, including this two-part building article from the May and June 1985 issues where *Phil Kraft's* original article was included. Today, both RCM article and RCM plans are available for download from the [Outerzone](#) vintage plans website.

The original article from the May-June 1966 GRID LEAKS issue including the two-page plan is shown in this document (in the History chapter below). All GRID LEAKS issues are available in the Web. See [here](#) for volume 7 number 3 to find the Ugly Stik article with plan. Today both the article and the full-size plan are available for download from the [Outerzone](#) vintage plans website.

The original publication date and issue are confirmed in the Vintage R/C Society's [Eligible Aircraft Listing](#) at page 3. They also mention that the full-size plan was available from the John Pond Plans Service as plan 35G5, so it is now available on paper from the [AMA plans service](#) (as well as the Jensen kit plans).

A source in a different sense is where you may get the REFLEX XTR² model flight simulator (that's the official name). It is available in a modern version that is particularly interesting for its multicopter (drone) simulation. It comes with all modern [EPP models made by Multiplex](#) and airplane physics is improved for new versions if need be, so the Ugly Stik models fly pretty realistically. Customary (game-controller compatible) USB simulator interfaces (with cable or wireless) can be used to connect your actual transmitter; the special interface is no longer needed (but still works). So just the software is easily available for download in a [web shop](#) (for MS Windows only), even as a free trial version.

Some information about the simulator is in [my personal review](#) web page, and several simulator versions of vintage and modern models are available on [my download page](#). The simulator models of Das Ugly Stik are [here](#).

Trivia

There is a [thread on RC Universe](#) about Das Ugly Stik with valuable information in it, for instance the article without plan [in this post](#).

Somewhat later appeared a rather lengthy [build thread on RC Universe](#) holding some interesting information as well.

Lyman Slack mentions the Ugly Stik two times on his [Web page](#) (near bottom) because he built it two times. Quote:

» Ugly Stik trivia: Did you know Phil Kraft had his plans for his first Ugly Stik published in GRID LEAKS magazine back in May/June '66? The plans show a Veco .45 up front surrounded by a round cow! It also had wheel brakes, a pilot, and a gun. «

There was a discussion about the "History of Classic Pattern" at [RC Universe](#) with several nice and interesting stories told, especially about five year old Chip Hyde flying an Ugly Stik (posts [#10](#) and [#41](#), see also at [RC Groups](#)).

Take a look at the Vintage R/C Society's [Pattern Sequences](#) Web page. You'll find that the full vintage pattern schedule could be flown with a Stik!

Ed Moorman recommends various "second" models for beginners at his (now extinct but archived) [Web page](#) and explicitly recommends a stick type even though or just because it may seem antiquated. Quote:

» Phil Kraft's original Ugly Stik, (from the 60's expression, "It looks like it was hit with an ugly stick") has to be the most copied and cloned RC plane ever. It has to fly well or no one would buy the thing! Any of the "Stick" type planes, Big Stick, Sweet Stick, Little Stick, Middle Stick, Joss Stick, Ugly Stick, Super Stick, would be a great flier. They can change their spots from mild to wild depending on the engine and control set-up. You can learn to fly on one and then you can change to a larger engine and do anything you want and still land like a trainer. I like them built without dihedral and with a .60 in the 40-sized version. The trouble with recommending a Stick is they have no pizzazz and most have gone out of production. «

People may think differently about "Uncle Willie" and his website. But he presented images of the original Jensen kit plans and flyer on one of his Web pages (now probably rightly defunct) and that made rendering the model in REFLEX XTR² possible in the first place. And his characterization was well to the point:

» Ever since the legendary Phil Kraft designed the Das Ugly Stik in the 60's, the familiar profile of the stick has been as common as a Cub at every flying field. Now you too can own the plans to the "original" Stik and enjoy the fun of a "knock-around" general-purpose sport plane with very little investment in building time and material. The greatest thing about a Stik is that it can be mild or wild, depending on the power plant. «

Imprint

... sort of:

Yes, I know the simulator model isn't *completely* correct, but it's *quite* correct. If you notice any deviations from the real model you're simply too close or too critical. Just relax and enjoy the look and feel of this great classic!

But if you're one of those veterans having own experience flying the original Ugly Stik, I'd surely like to hear from you any corrections or suggestions.

And if you have any other pertinent contributions, suggestions, or corrections whatever, I'd surely like to hear from you as well.

Anyway...

Enjoy!

Burkhard Erdlenbruch

<mailto:Burkhard@Erdlenbruch.de>

<http://time.hs-augsburg.de/~erd/Modellflug/textReflex.html>

More REFLEX XTR² models and the latest versions are on my page

<http://time.hs-augsburg.de/~erd/Modellflug/textDownloads.shtml>

© April/November 2006,
upgraded April/July 2008,
brushed up April 2010,
amended July 2013
amended September 2014
amended April 2015
joined and upgraded April 2017
corrected January/June 2019

Chapter 1

Jensen Kit Version

The first and most popular kit Version.

Many modelers had the kit of Das Ugly Stik made by *Jim Jensen*. That mainly determined the image that people had of the Stik. Though several modelers built the Stik after the original plan published 1966 in GRID LEAKS magazine, obviously far more noticed and appreciated the kit that was available for a long time, and the plans belonging to it, which were even brushed up and re-published with building instructions by RCM magazine in 1985.



This was a flyer advertising (and being enclosed in) the Jensen kit. It shows the model in the most popular paint scheme being suggestive of a German WWI airplane. It's the same as in the original GRID LEAKS plan, but the fancy "frills" – engine cowl, pilot and gun – are omitted. A second paint scheme following American WWII trainer airplanes has been added. This may be adequate to a trainer and sport model but obviously never became popular. Moreover, an ancient-style "German" lettering – aptly named Gothic – has been used for the model's name on kit and plans, so the first paint scheme became *the* livery of Das Ugly Stik. Both have been applied to simulator models, though.

Besides omitting the frills, the customary three degrees of dihedral have been worked in. The originator simply felt the model looks better with it. The boxy shoulder-winger design lets the

straight wing look like drooping. Nevertheless, some modelers (like *Ed Moorman*, see below) preferred the straight wing (or even anhedral) for its better aerobatic performance. So at first Das Ugly Stik for the REFLEX XTR² simulator has been made conforming to the Jensen version, and then additionally with straight or anhedral wing, respectively, and a strong engine.

Contributions

Well, these “contributions” to the simulator models were actually involuntary. I simply borrowed some hard-to-get components of the REFLEX XTR² models from other authors. At least they should be given credit here:

Bo (Jörgen) Strömberg from Sweden made the engine for his excellent Graupner Taxi for REFLEX XTR². He published it on RC-Sim in August 2005 (see [here](#)) and later granted permission to use the engine model. Thank you very much!

This engine is especially well suited because it’s a Veco, a brand which was in widespread use. Actually, it’s a smaller size (a .21), but that doesn’t matter. It’s simply enlarged to mimic a .45 or even a .60 on the Stik.

The built-in REFLEX XTR² standard propeller has been replaced by a wooden Master Airscrew. In the visual model, diameter is 11” and pitch is 7” or 8”. The texture is borrowed from one of the many Internet shops.

The wheel textures are borrowed from a REFLEX XTR² stock model.

The “old” two-stroke engine sounds were borrowed from *Thomas Hanser* (see [RC-Sim](#)) who published them with his Westerly and Extra models on RC-Sim. The idle sounds are the same anyway, only the full power sounds are different, more rpm for the “wild” and less for the “mild” model. I don’t know if he recorded the sounds and from what models, and I think he wouldn’t mind that they’re used for the Stik.

New high-quality REFLEX XTR² stock sounds are assigned to both Jensen versions as well as the straight-wing and anhedral versions. The old two-stroke sounds are yet installed, though, so you may assign them if you like them better (F5 “Model parameters aircraft”, “Engine sound”).

And yes, [RC-Sim](#) supplied these other models and their sounds.

Appearance

Because I intended to revive the original Jensen kit version, I actually didn't think of making any variants, not even the straight wing without dihedral. Of course, there are as well no other airfoils, bigger control areas, higher horizontal tail, or taildragger landing gear. These would all give noticeably different models, which would have to be especially rendered in REFLEX.

After getting the old GRID LEAKS magazine article I somewhat changed my mind. *Eric Wildermuth*, who provided the article for me, drew my attention to the fact that someone later added the wing dihedral, perhaps because the straight wing looks as if it is drooping (has anhedral). *Phil Kraft* aimed at utmost building simplicity. Maybe he didn't bother about flight behavior, which is nearly the same in the simulator. Nevertheless, there is a straight-wing and even an anhedral variant for REFLEX for those who want to try it.

The shape of a model in REFLEX is made of polygons. Many polygons and a lot of work were spent on the wing's ribs-and-spar structure. Viewing from certain angles, you'll see the wing covering sagging between the ribs and spars. You'll have to keep some viewing distance, or the wing will look a bit angular and awkward.

Adequate to this viewing distance, details were applied to the model's raw body. These are control horns and linkages, mounting dowels and rubber bands for wing, main landing gear, and nose hatch, and the antenna.

The landing gear is fully detailed and working like the real one. The nose landing gear protects the propeller, the tailskid is necessary to protect the horizontal tail in high-pitch attitudes and when bumping on rough runways. Only the wheel brakes are omitted because REFLEX can't render them.

I think every sample of the Stik was different, and the Stik for REFLEX is even close to the Jensen plans in detail and texture. Only a few details are omitted to make modeling work easier, but that shouldn't matter.

There is even one departure from the 1966 plan: It shows *Phil Kraft's* usual back-plate engine mount in a position for horizontal cylinder. Back then, the engines were rather small and had no muffler. Not much later (in the late 1960s), engines were bigger and had mufflers so beam engine mounts were used and the engine had to be slanted so the muffler was clear of the fuselage. That is rendered on the simulator models.

Jim Jensen adopted the paint scheme being suggestive of a German WWI airplane for his kit, but he thought he should have an American paint scheme as well. That's why *George Walker* additionally sketched the second scheme, following American WWII trainer airplanes, in the kit plans. Fittingly, the "German" livery has been used for a powerful "wild" version and the "American" livery for a "mild" trainer version in the simulator:

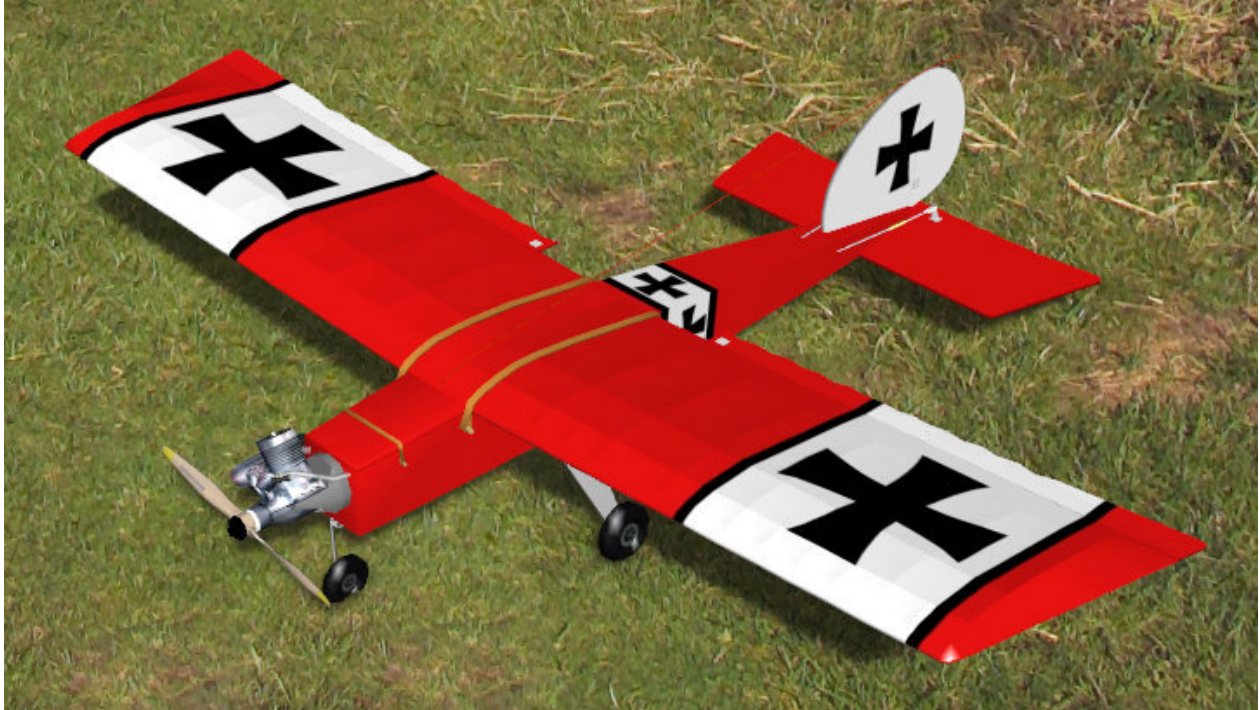

German Cross or Stars And Stripes – what’s nicer? Maybe when I was young I had decided on the more aggressive look and the “wild” behavior of the first version. Now I seem to prefer the friendlier look and the “mild” behavior of the trainer version. At least I spent hours just taxiing around, looking at the cute model and watching how the landing gear legs are working.



The paint scheme's elements were detailed in the Jensen kit plans, except the red diagonal wing stripes of the American paint scheme. They are only in the picture on the flyer. Probably *Jim Jensen* had built a Stik for himself, maybe a pre-production kit, and had added the stripes to the scheme, which *Dick Kidd* had on his own Stik prototype and a PT-19 model before.

Not even *George Walker* really knows if dark blue was used for the fuselage. *Dick Kidd's* model had it, but some PT-19 aircraft had a quite light blue, and the eagle-image stripe is better silhouetted against it. So I finally opted for light blue even if the fuselage color looks rather dark in the flyer picture.

By the way – you may exchange both looks, making the German version behave “mild” and the American “wild”. In REFLEX, simply select the other model appearance in the model parameters dialog (F5).

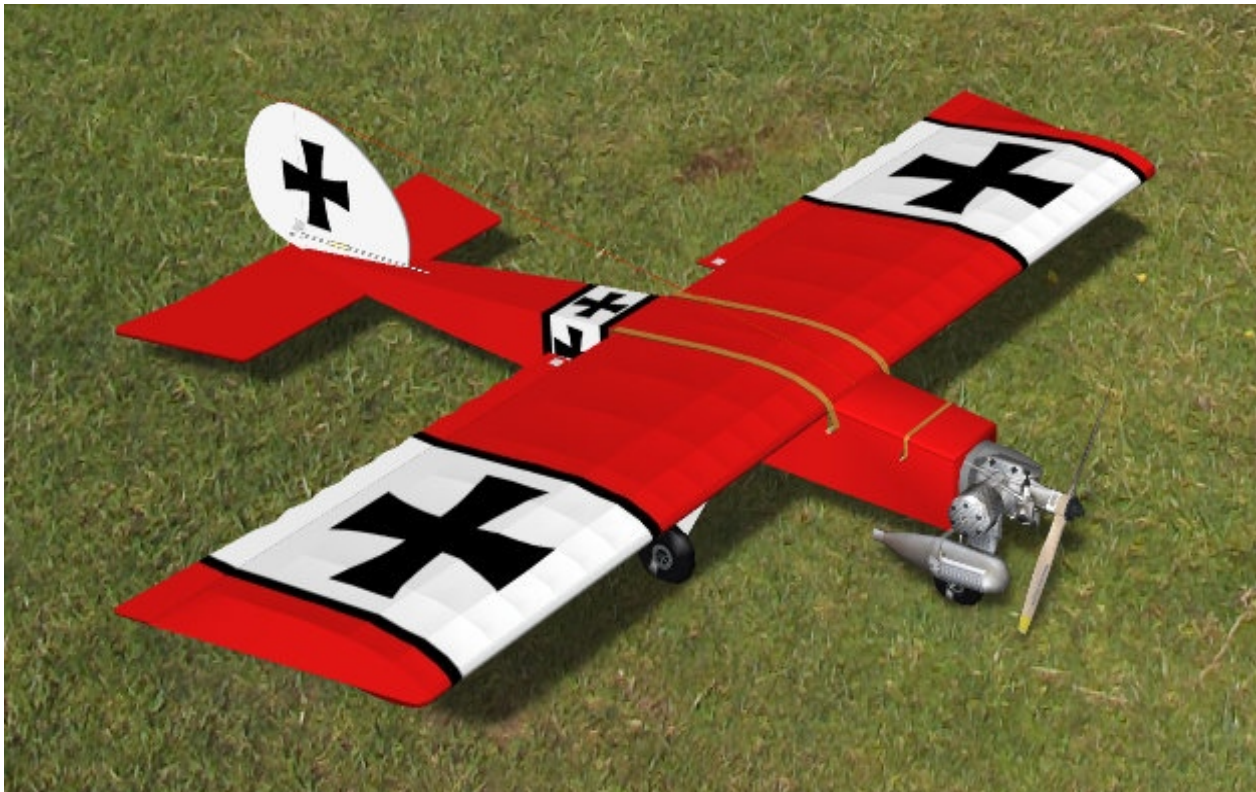

But you better leave the straight-wing variant alone because it's the special “hot rot” version. The O.S. MAX 60F SR is a powerful .60 engine of the 1970s and is side-mounted to have the carburetor and the tank level. Several parameters are different from those of the “wild” version.

For instance, the center-of-gravity is slightly (0.275 in / 7 mm) right of the centerline due to heavy engine cylinder and muffler. There's a noticeable effect in loops and other high-G maneuvers. The C/G is also very slightly (0.08 in / 2 mm) lower than in the other versions, but this makes virtually no difference in flight behavior. You may change these C/G settings yourself in the “Physical parameters” dialog box (F11), “General data” tab.

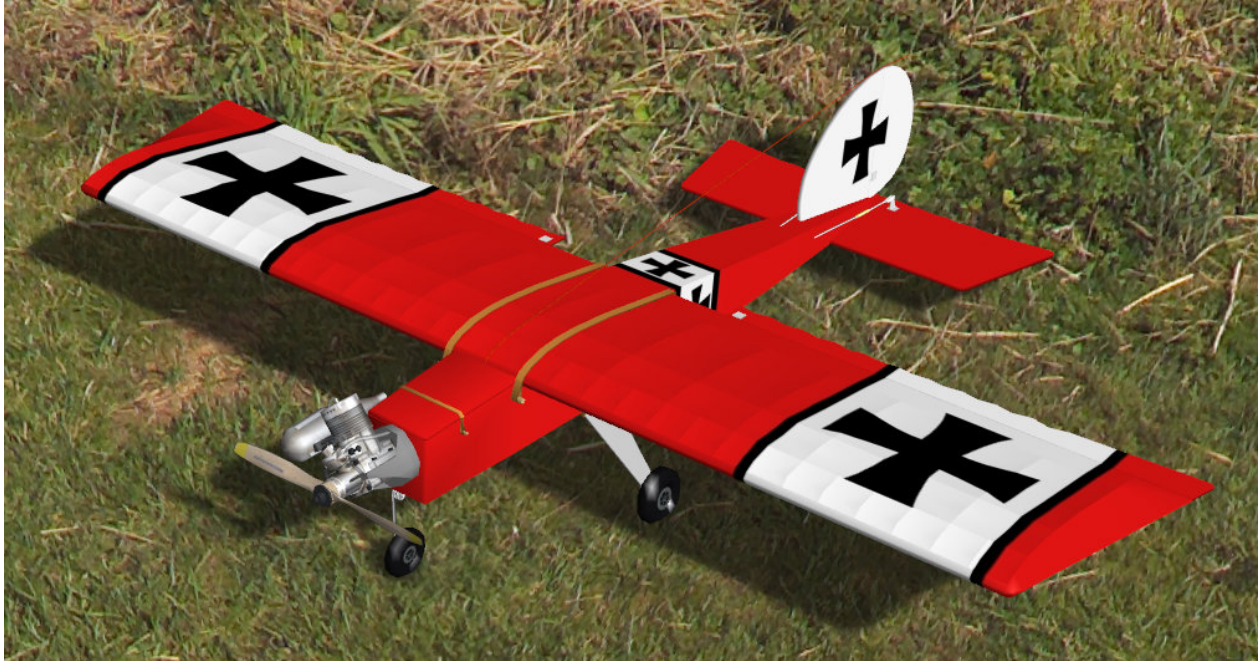

There's even a second straight-wing ("hot rod 2") version where the engine's cylinder is not horizontal but slanted by 40 degrees so the muffler is alongside the fuselage and not below it, like on the "wild" version and roughly like shown in the later RCM plan.

And there's another version with 2 degrees anhedral ("hot rod anhedral"), that is really drooping wings, which flies even better, that is more neutral in roll and yaw (*Ed Moorman* [about that](#)):

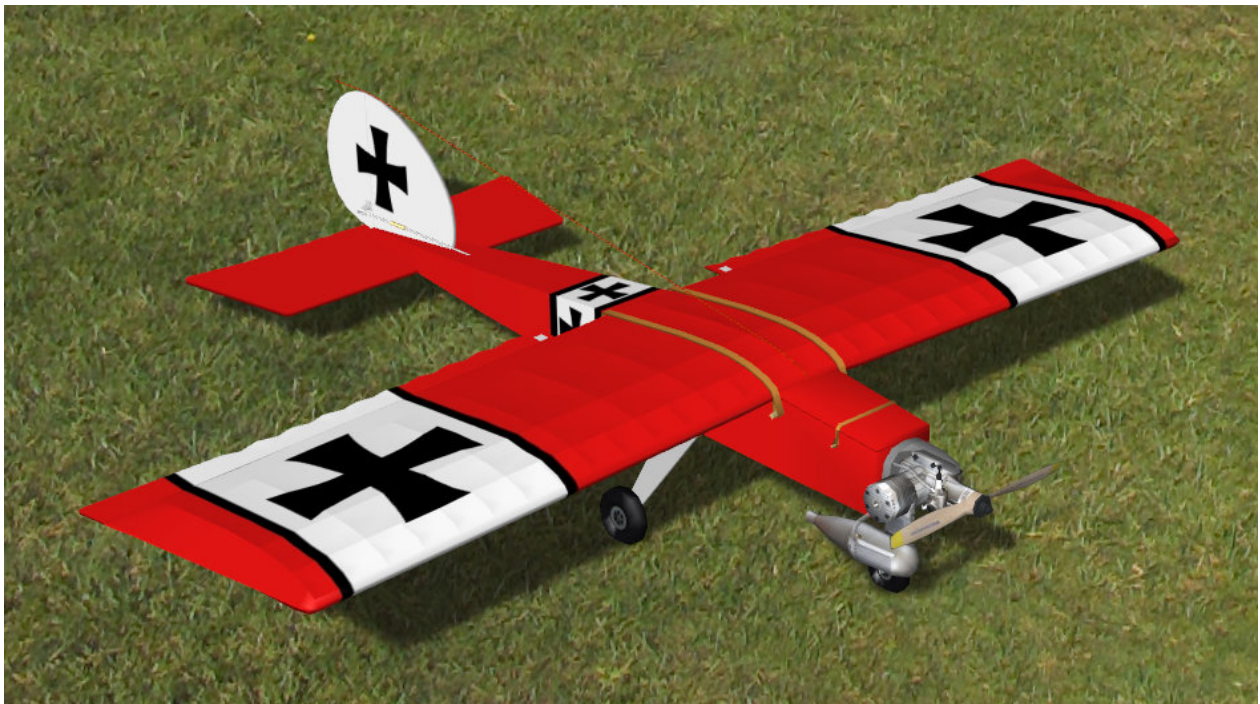

Setup

The old proportional radios were no computer radios and had neither expo nor dual rate. Things being a radio setting today required changes on the model in the old days. That's why you get different Stik versions for REFLEX, differing not only in appearance but also in setup.

Phil Kraft produced and used servos with linear actuators (not the rotary arms of today's servos). Of course, the control horns are rotating around the control axis. Thus, linkage geometry makes for some expo effect. The rotary control deflection increases progressively faster from neutral to end than the linear servo movement. In REFLEX, this is imitated by a – guessed – expo setting, smaller for the smaller control throws of the "mild" version and bigger for the bigger ones of the "wild" version.

The old radios had no aileron differential, either. Instead, only one wing servo was used and linked to the ailerons by spanwise pushrods, 60-degrees bellcranks and pushrods back to the control horns. That gave a nonlinear differential, which is approximated in REFLEX by an estimated linear setting.

Maximum control throws are parameters in REFLEX, the other mentioned parameter settings depending on them. Thus, it's not possible to simply dual-rate switch between two Stik versions. Instead, a separate parameter set is needed for each version.

Only the plan published 1985 by RCM has control throw recommendations, given in inches. Converting them gives very small 11 to 14 degrees deflections. These seem to be too small even for the "mild" version, at least in the simulator, so I arbitrarily chose sufficient deflections for this version and stepped them up by 5 degrees each for the "wild" and again for the "hot rod" version.

Other version differences are mainly in the weight and the drive parameters. Actually, weights were a wild guess, a bit more for the "wild" version with the bigger and heavier engine. But they proved to be quite correct according to *Phil Kraft's* article in the GRID LEAKS magazine.

The drive settings are based on power and torque measurements published in an older book. It seemed suitable to assume a 1960s .45 or a .60 O.S. engine and an 11x7" propeller for "mild" and "wild", respectively. They're working well, the bigger one with more power and rpm, just in the ratio of 60 to 45. So it has not only more thrust and torque but also more pep at high speed. The "hot rod" version with a 1970s .60 O.S. engine is even more powerful with the same 11x7" propeller.

No engine down thrust (to compensate for nose-up tendency) and right thrust (to compensate for torque) was applied following *Phil Kraft's* recommendation and both are not needed either.

Flight Behavior

As usual, I took the geometry from the plans and put it into *Blaine Beron-Rawdon's* excellent Plane Geometry spreadsheets (see the overview on [his Web site](#)). The airfoil and wing coefficients were calculated in an own spreadsheet. All calculated values and the C/G position (balance point) from the plans were simply transferred to REFLEX – and the model worked right away, no tweaking or fudging needed!

Of course, some values had to be guessed because I had no information about them. Some plausible assumptions were made for the airfoil, using German low-Re measurements for analogy. Later being aware of the *semi-symmetrical* (cambered) airfoil, I modified the airfoil parameters from the symmetrical setup to a semi-symmetrical one, what didn't change much, though. Overall flight behavior is mainly determined by geometry.

The wing's aspect ratio is rather small (4.7), thus wing area rather big and wing loading low. This makes for good slow-flight capabilities, particularly because induced drag will be high at slow speed – no flaps needed, neither as lift enhancers nor as brakes. Induced angle-of-attack (AoA) is big, making the model insensitive to pitch changes. Due to the rectangular planform, no *tip* stall can occur – on the one hand.

On the other hand, the airfoil designed by *Phil Kraft* for the Ugly Stik has a rather sharp leading edge. This justifies a reasonable stall setting in the airfoil parameters. That means the model *will* stall, just good-natured and not vicious. But if rudder is applied in a stall situation, the model may also snap.

A spin must be initiated by applying full rudder when approaching stall (like in a Cessna 172 which actually refuses to spin). A snap roll is initiated by applying full rudder and elevator at the same time (the old-school method), maybe elevator somewhat leading rudder.

The "mild" version does not even have enough control authority for a spin, not to mention engine power for a snap roll. So it prevents the beginner from unintentionally entering such a maneuver and crashing the model. Even though the "wild" version has both, it still won't actually spin or snap and thus allows blithely knocking around the plane.

Not even the "hot rod" version has the required backward center of gravity, but it has more control throw and a straight (or even anhedral) wing. It enables the expert to do any maneuver in the (Aresti) book, but it's still very hard to spin or snap-roll. Only with aid of ailerons a good-looking snap roll will succeed. It's a quite straight snap roll, even more so with anhedral wings, which also make for very straight axial rolls. The anhedral wing version has virtually no yaw-roll coupling, even if some pitch-up with yaw.

Even the expert might limit the control throws (on a modern transmitter simply with the dual-rate switch) and reduce power (restraining his nervous fingers). This way he has the same unswerving and imperturbable model as the beginner and may bring it in for landing with low speed, and he may even smack it on the runway like a beginner does.

Incidentally, a straight or anhedral wing should be combined with no aileron differential. There is some loss of directional stability and the model is not controllable with rudder only. But there is nearly no (straight wing) or no (anhedral wing) roll-to-yaw coupling and the roll rate is slightly increased.

This behavior is what I would expect of a model having the Stik's geometry. REFLEX is amazing because it credibly renders all this flight behavior. I think the Stik is simply the type of model REFLEX was initially made for – about 25 years ago now. And that's why I think this rendering is realistic – even though I don't know for sure, of course.

Chapter 2

Rotary Engine Variant

System NSU/Wankel, by Graupner/O.S.

The Graupner/O.S. rotary engine was one of the very few rotary engines produced for a long time. Since 1970, when production started, it had only few but devoted users. After a major redesign in 1982 it was named 49-PI and rated as a 4.97 cm³ / 0.303 cin glow engine, performing astonishing 0.94 kW / 1.27 hp at 17000 rpm and weighing only 395 g / 13.9 oz including muffler and mount. In 2006, O.S. brought out an enhanced successor named RE 49 PI-II, which was quite a bit heavier (455 g / 16.0 oz) and less powerful (0.81 kW / 1.08 hp at 17000 rpm) but hopefully more reliable in return. As of 2016, this engine is definitely discontinued by O.S., its manufacturer.

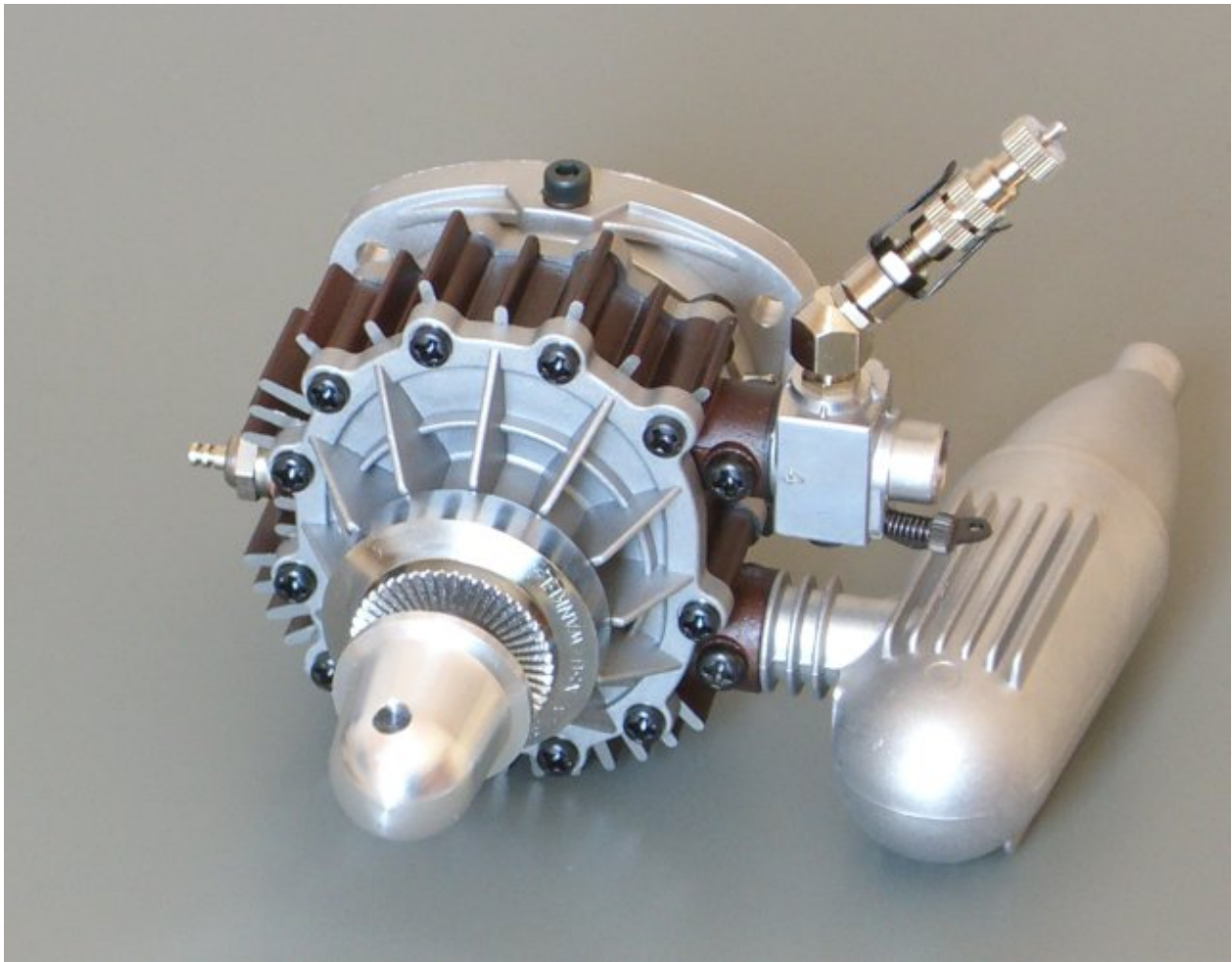

It's a perfect match for Das Ugly Stik. Even Graupner had a Middle Stick kit for this engine since 1970, but that was the first version with only 0.63 hp power output at 16000 rpm. Since the early 1980s it had the same power output as an O.S. MAX 60F SR of 1974, just at 1.25 times the rpm and with 0.7 times the weight. Now it makes the full-sized, original Das Ugly Stik a really "wild" model, only slightly different from the O.S. 60 of the 1970s, but thus 25% more powerful than the .60 engines of the 1960s. With a hot fuel it would even go up to 1.5 kW / 2 hp at 20000 rpm.

I own a Graupner/O.S. 49-PI (picture above) just as a technical marvel, not for use on a model. And I felt there's another connection to Das Ugly Stik: *Felix Wankel*, the inventor of the rotary engine, wasn't an engineer whatever but a self-made man, just like *Phil Kraft*, the designer of Das Ugly Stik and other famous models as well as some well-known radio control sets. So it was just the obvious for me to combine the model and the engine.

Engine

Biggest advantage of a rotary¹ engine is that it's nearly free of vibrations². R/C components in a model are delicate instruments and have to be carefully protected from vibrations. Maybe that's why Graupner – market leader at least in Germany – was interested in the rotary engine as early as 1960 and kept up development till 1970 and then production for 45 years.

Further advantages are power output and compactness. The engine is small and fits well in a fuselage cowl or a nacelle. Compared to a "normal" engine (a two-stroke glow engine for model aircraft) of same displacement it has twice the power and half the weight. The Graupner/O.S. engine showed that only after a redesign, though, when technical problems had been solved.

There are disadvantages – you guessed. One point is high rpm, what means less thrust and makes the engine more suitable for ducted-fan applications. The small torque makes aerobatics more pleasant, though, even if the high flight speed would better fit a "rocket" model of the 1980s than a Stik. And even though the engine is quiet (compared to two-stroke engines), the prop

¹ Rotary engine is an English designation. In German, engineers distinguish between rotating-piston engines and revolving-piston engines (hopefully correct translation). Felix Wankel, who systematically invented piston machines and the necessary sealing, developed the former. The first and most important licensee of his patent was NSU, a company producing motorcycles and small cars in the 1950s. Their chief engineer obviously didn't like the rotating-piston concept and modified it to the revolving-piston concept. All production rotary engines are designed this way and still often called Wankel engine. Graupner/O.S. correctly call their engine „system NSU/Wankel“, though.

² Different from a reciprocating-piston engine, there are only *rotating* parts which can be balanced completely, so there are no radial vibrations. Of course there are torque vibrations as in any piston engine, but the rotary engine has three ignitions per piston revolution, equivalent to a three-cylinder two-stroke engine. Besides, the ignitions are not that violent.

is very loud at 17000 rpm or more what excludes the rotary engine from use at many noise-restricted model airfields.

More disadvantages are fuel consumption and exhaust emissions³. The recommended 11 oz tank gives only 10 to 12 minutes flight time, meaning a fuel consumption 50% higher than that of the 60F SR. Incompletely burned parts of fuel and the Castor oil are thrown backwards by the engine, and it needs a lot of of this oil. So the model has to be carefully sealed and impregnated and must be thoroughly cleaned after each flight.

Models

On the 3D model, the Veco engine is replaced by the Graupner/O.S. rotary with a smaller 9x6" propeller. The engine is in the right place, but it had to be turned carburetor and muffler up. The muffler is so close to the engine that it is clear of the fuselage only this way. Dowels and rubber bands are replaced by modern Nylon bolts. The rest is virtually the same.



³ Due to heat losses through the big combustion chamber surface, efficiency is bad. That's also why the model rotary engine gets really hot and needs a lot of cooling by rich fuel-air mixture! Due to the combustion chamber's complex shape and difficult sealing, the engine exhausts incompletely burned fuel, and the model engine exudes oil through all pores. Only Castor or synthetic ester oils put up with the high temperatures.

I couldn't resist making a new livery. Because the rotary engine is a German invention, the model has a German patriot skin. These are our modern [flag colors](#) (not bad at all, though the shape may be suggestive of a bat). And the German cross is drawn according to the modern regulations, just over-sized.

The parameter setup of this rotary version is virtually the same as for the "wild" version; only the drive parameters are modified. More thrust and less torque are set compared to the 1960s .60 engine of the "wild" version. The lesser weight is reflected in less overall weight, and the smaller frontal area in less drag. I have no clue if the parameters are realistic.

But realistic engine sound was borrowed from two sources. While the engine sounds like a racing car at full power, the rattle of the rotor gearing and maybe the apex seals determines the idle sound. Rather high smoke density is set to render the engine's dirty exhaust.



To appreciate the Graupner Middle Stick featuring the new rotary engine in 1970, this model was built as well and clothed in the original checkerboard style livery. This is a design typical of the 1970s, still looking good today.

As an original Middle Stick, this model has a wire main landing gear and a straight nose landing gear as well as a Graupner Super Nylon propeller. The second version rotary engine is shown because the first version was not available for copying. It could be mounted with the muffler on the left-hand side because the firewall is smaller on this smaller model.

The Middle Stick is “middle” regarding the physical parameters. The first version of the rotary engine called “1 49” was not that powerful, but the Middle Stick was somewhat smaller (55” instead of 60” wingspan) and lighter (81 oz instead of 100 oz weight) than an Ugly Stik. The control throws are set as in the original Ugly Stik version, allowing no snap or spin.

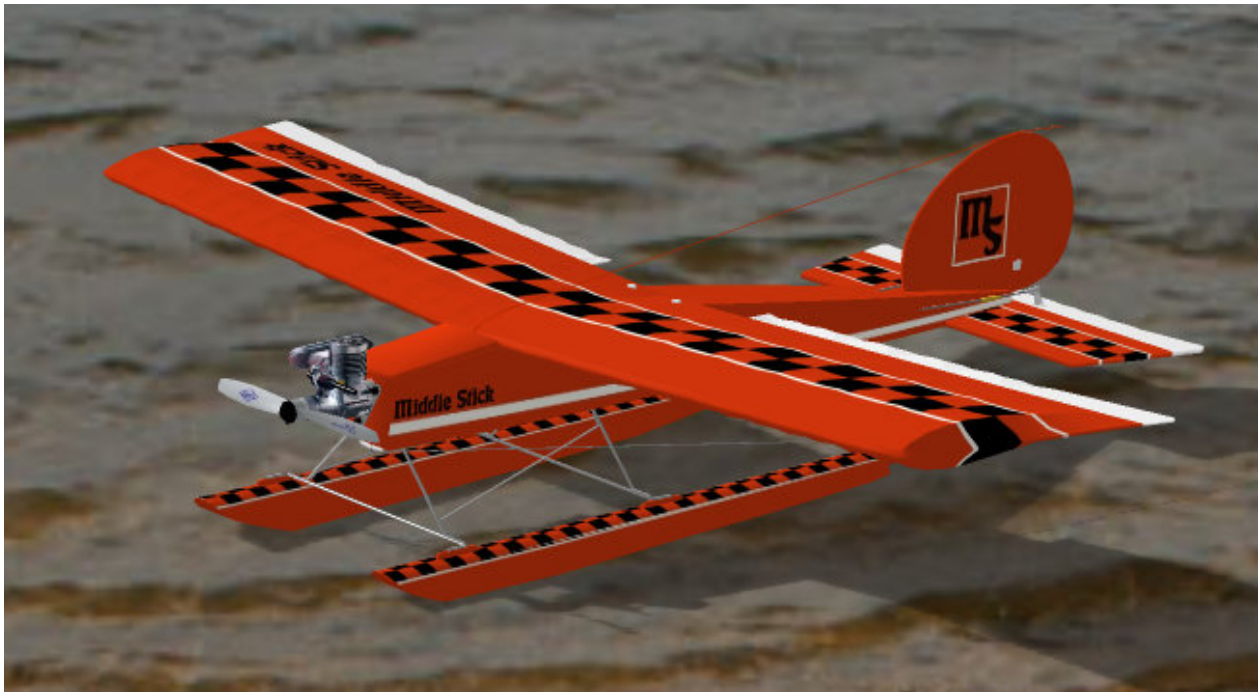

There’s also a floats version of the Middle Stick, and even though it’s equipped with a conventional (reciprocating piston) engine it’s described in this section just because it’s a Middle Stick. The rotary engine with its high rpm and small propeller makes the Middle Stick a quite fast model. For a float plane, more thrust from a bigger and slower turning propeller is needed so the rotary engine is not suited.

Still the Middle Stick is a good float plane because it is able to fly slowly and is very well behaved. This model clearly shows what floats do to an airplane. The weight is now 95 oz and the floats produce a lot of drag both on take-off and in the air. Thus the model has to fly faster to carry the additional weight whereas top speed is lower due to the bigger drag. So floats reduce an airplane’s speed range, but Middle Stick is still a lively performer and able to do basic aerobatics with the .40 engine used on it.

The floats are simple (29” long) round-top flat-bottom floats with wire struts. Even though there is no true “water” in REFLEX they are reasonably realistic in a suitable scenery. The water rudders are not functional in the simulator.

Sources

Comprehensive information (and a nice animation) on rotary engines in general has Wikipedia in a [special article](#).

A website devoted to rotary engines in aviation described the Graupner/O.S. 49-PI as "[the smallest Wankel of them all](#)" (now defunct but archived page).

Alan Marr had some information on his [Wankel web pages](#) (now defunct but archived pages).

Manfred Mornhinweg even wrote a whole [story about his 49-PI engine](#), comprehensively and competently discussing all technical aspects. Interesting site, by the way.

A website about O.S. engines is run by Hobbico. The "Manufacturing Timeline Gallery" shows the first rotary version as 1970 "1 49" in the [1969-1975](#) part and the second version as 1982 "49 PI" (peripheral intake) in the [1982](#) part. The [official Japanese O.S. Web site](#) disagrees on the year of introduction (1968). The latest model "49 PI-II" is now discontinued and no longer [there](#) at the O.S. engines Web site.

Maybe the full-power sound originally came from Graupner. There was a [model racing-car Web site](#) that is now gone but archived and was pointing to the Graupner Web site, offering the sound as a curiosity. And an [Audi car history Web site](#) links to this sound as a curiosity as well and calls it beastly. The car freaks found the sound similar to that of a formula-1 racing car.

The idle-power sound was extracted from a video that *Paul K. Johnson* has on [his Web page](#) about his very nice rotary-powered self-designed Stik 30 model. Interesting site, by the way.

All information about the Middle Stick came from *Roman Traussnig's* excellent [Web pages on old Graupner models](#). There are not only many pictures but also an [exploded drawing](#) and a [three-view drawing](#).

Information about the German flag is at [Wikipedia](#).

Chapter 3

Electric Drive Variant

Direct-Drive AXi Outrunner Motor and LiPo Battery.

In the last twenty years, electric drives got applicable to virtually all types of models, and today they seem to be even standard for sport models. Now what type of model is Das Ugly Stik? Exactly!



Especially ModelMotors in the Czech republic has a fair market share with its AXi line of brushless outrunner motors. And especially the AXi 4120 is often used to electrify sport models formerly powered by a glow engine. This picture is borrowed from the ModelMotors website where the motor is recommended for "sports aerobatic models up to 3000g".

Like all outrunners, these motors produce high torque at low rpm so no gear is needed. Weight is low and efficiency is high what applies also to the propeller. And with a rear mount the motor simply fits to the firewall.

Drive

AXi motors and Jeta speed controllers are like twins, both made in the Czech republic and both quite inexpensive for their performance and quality. Moderately priced LiPo batteries, with a good capacity to weight ratio, perfectly match this pair.

The motor weighs even less than the rotary engine (320 g / 11.3 oz), the 13" diameter propeller only 25 g / 0.9 oz. The 6000 mAh 4s2p LiPo battery is estimated to 680 g / 24 oz, the speed controller to 55 g / 2 oz. The overall weight of the drive should be 1080 g / 38 oz.

This might be even slightly more than the weight of an old .60 drive with engine, propeller, muffler, mount, servo, and tank with fuel. But instead the modern R/C components are lighter than the old ones. So the simulator model's overall weight is assumed to be slightly lower than that of the "wild" version. But the performance of the electric drive is even better than that of the (old) glow drive. Once the electric drive cost more than the glow drive, but that has changed since, and there is no expensive fuel needed.

Obviously, we witnessed a revolution in model technology. When prices got lower, more and more people became a convert to electrics. No more oily (and hurt) fingers, no refueling and complicated engine start-up, no needle valve adjustment and engine stop in flight, no awkward model cleaning, no noise problems and even more powerful drives – that’s just too tempting. Supposedly even *Phil Kraft* would have converted, how *Hal deBolt* reportedly did. And converting Das Ugly Stik is no sacrilege, it’s just logical!

Model

The more “modern” rotary version of the Stik for REFLEX was taken and both engine and livery were replaced.

Unfortunately, I had no good idea how to design a new skin for this version. Since all three previous versions utilized some national symbols, one idea was to pay tribute to the Czech contributions. On the other hand, I was too lazy to draw a complex texture. The Czech flag with its blue triangle nicely fits the round vertical tail of the Stik. The flag structure could also be used for wing and horizontal tail. It looks as if they were swept forward, but that’s not bad at all. At least one can distinguish left and right side in aerobatics.



Sources

Information about the “Czech flag” is found via Google using just these two words.

Motor picture and parameters were taken from the [ModelMotors website](#).

The motor was modeled using the drawing on this website, and the propeller was modeled after a real APC sport propeller.

The drive parameters for REFLEX were calculated in my own spreadsheets. Not this but similar drive calculations are available on [my download page](#).

The sound is borrowed from REFLEX, it’s the generic electric sound because I had no better one.

Chapter 4

GRID LEAKS Version Das Ugly Stik

GRID LEAKS Magazine Article and Plan.

Many modelers had the kit of Das Ugly Stik made by *Jim Jensen*. That mainly determined the image that people had of the Stik. Yet several modelers built the Stik after the original plan published in GRID LEAKS magazine. So while Das Ugly Stik for the REFLEX XTR² simulator had been initially made using the Jensen kit plan, another version has been made later, now using the “original” GRID LEAKS plan.

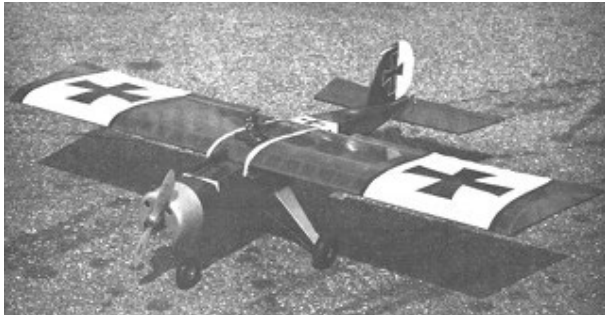

ACE R/C Inc., GRID LEAKS magazine’s publisher, sold the full-size plan via their GRID LEAKS plan service, and advertised it in their catalog with this picture from the short but informative 1966 article by *Phil Kraft*. (The whole article is reproduced in the History chapter below.) There were no real instructions for the one-sheet plan,

printed in smaller (two-page) size in the magazine. It’s just mentioned how the model was designed for utmost building simplicity.

No jig is required for fuselage and wing. To this end, the fuselage is built on its flat bottom. The wing is straight, has no dihedral, and the ribs have a flat lower edge from the main spar to the trailing edge spar. So the wing is built flat on the building board as well.

Plan

Originally, the model was a mere test-bed for R/C equipment and completely “square”: square wing including tips, square horizontal and vertical stabilizer (see next chapter). It was commonly seen as really ugly, but *George Walker* had the idea to embellish it so it would look, even if still ugly, at least interesting. He built the prototype shown in the picture above and drew the plan.

He drew the Jensen kit plan as well, but meanwhile he had added dihedral and *Jim Jensen* wanted to omit the pure frills. So the Jensen version is lacking engine cowl, gun, and pilot, which are shown in the picture above and in the GRID LEAKS plan. They had to be added to the simulator model while the dihedral had to be removed. The rest could remain as it was.

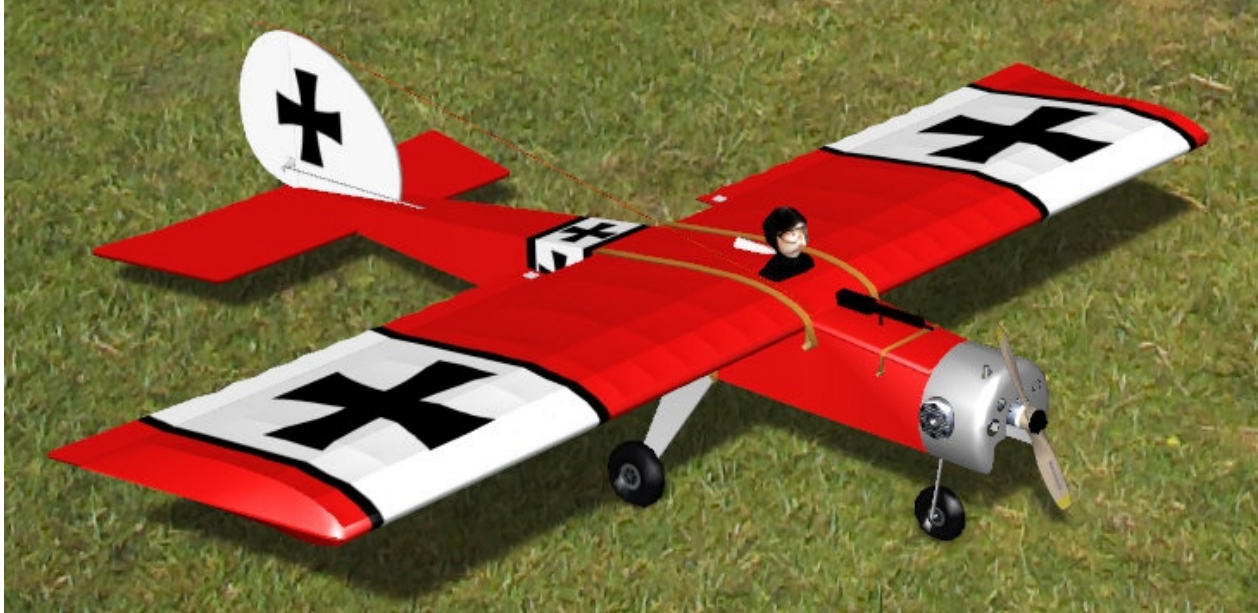

George Walker might have been inspired by a Fokker Eindecker (German for monoplaner) in a "Red Baron" trim, though Richthofen (called the Red Baron for his red-painted aircraft) had been flying an Eindecker only for a short time and probably not a red one.

Anyway, *George* thinks that he saw the typical vertical tail on a German Albatros biplane and adopted it including the coloring – red fin and white rudder, like in the monochrome picture above. Later, when *Dick Kidd* built another prototype for *Phil Kraft*, they found an all-white vertical tail prettier. That was drawn in the plan as well as rendered on the simulator model.

I don't know if and why the German Cross is popular outside of Germany, but it seems to be crucial for the model's looks. If you would like to know more about it, you could look at [Wikipedia](#) for 'Iron Cross', the correct name.

The pilot (even with scarf) and gun (even with sight), as well as the engine cowling, are mere frills making for an interesting look. More important are the external aileron linkages omitted in the other REFLEX model versions for simplicity. Though they are mostly invisible under the wing, they make a real difference to the Jensen Version.

Because the bellcranks are rectangular and not 60 degrees as in the Jensen version, there's no aileron differential. That is reflected in the physical parameters but has only a small effect on flight behavior in REFLEX, as well as the straight wing without dihedral.

There are other details making a noticeable difference. In addition to the "semi-symmetrical" airfoil caused by flattening the ribs' lower edge, the plan explicitly shows a wing incidence angle of about 0.5 degrees. This is also the decalage. Setting that in the physical parameters, along with slightly "asymmetric" airfoil coefficients and a small amount of airfoil pitching

moment, resulted in an even more credible and realistic flight behavior than in the earlier versions of the REFLEX model (which have been correspondingly readjusted after this).

Phil Kraft writes that no engine right or down thrust was used. Setting also that in the parameters gives a surprisingly neutral flight behavior. You have to apply right rudder during the take-off run and in the high-lift parts of a loop, but that could be seen as normal for aerobatic models.

This version has .45 size engine power and quite big control throws, so it will fly lively but neither spin nor snap. That should match the intentions expressed in the article and the plan where the Veco .45 is drawn. Because there was no muffler, the louder sound of the "wild" version is used.

Sources

Eric D. Wildermuth from Brisbane, Australia, kindly provided scanned images of his copy of the May-June 1966 GRID LEAKS magazine article and also had valuable information from his rich experience building and flying several Ugly Stiks. Thank you very much!

Members of the Vintage R/C Society scanned all old GRID LEAKS issues and put them on the Web. See [here](#) for volume 7 number 3 to find the Ugly Stik article with plan. It was also shown without plan in an [Ugly Stik thread](#) on RC Universe.

Today both the article and the full-size plan (scanned PDFs) are available for download from the [Outerzone](#) vintage plans website.

The pilot is taken from a Fokker DR-1 model for REFLEX XTR² published in 2004 [on R/C-Sim](#) by *Eric Fague*. He converted it from an FMS model made by "[Logic Wizard](#)". This pilot looks even very similar to that used 50 years ago and depicted in the plan, which says it's from [Williams Brothers Model Products](#), and their unpainted standard pilot figure today looks not different.

Chapter 5

Prototypes

George Walker's own one and *Phil Kraft's* built by *Dick Kidd*.

The model shown on the GRID LEAKS front page and in two of the pictures in the article is *George Walker's* prototype. It's all red, and the wing is covered with red dyed silk and painted with clear dope, so it's translucent. The pilot has a scarf made from a scrap piece of red silk. The fin is red and only the rudder is white. The engine cowl is painted with silver dope.

The model shown with *Phil Kraft* in two pictures is his own one, built for him by *Dick Kidd*. It has an all-white vertical tail, and the pilot has a white scarf. The engine cowl has been removed for better access to the engine, at least as long as the engine was not perfectly run in and adjusted.

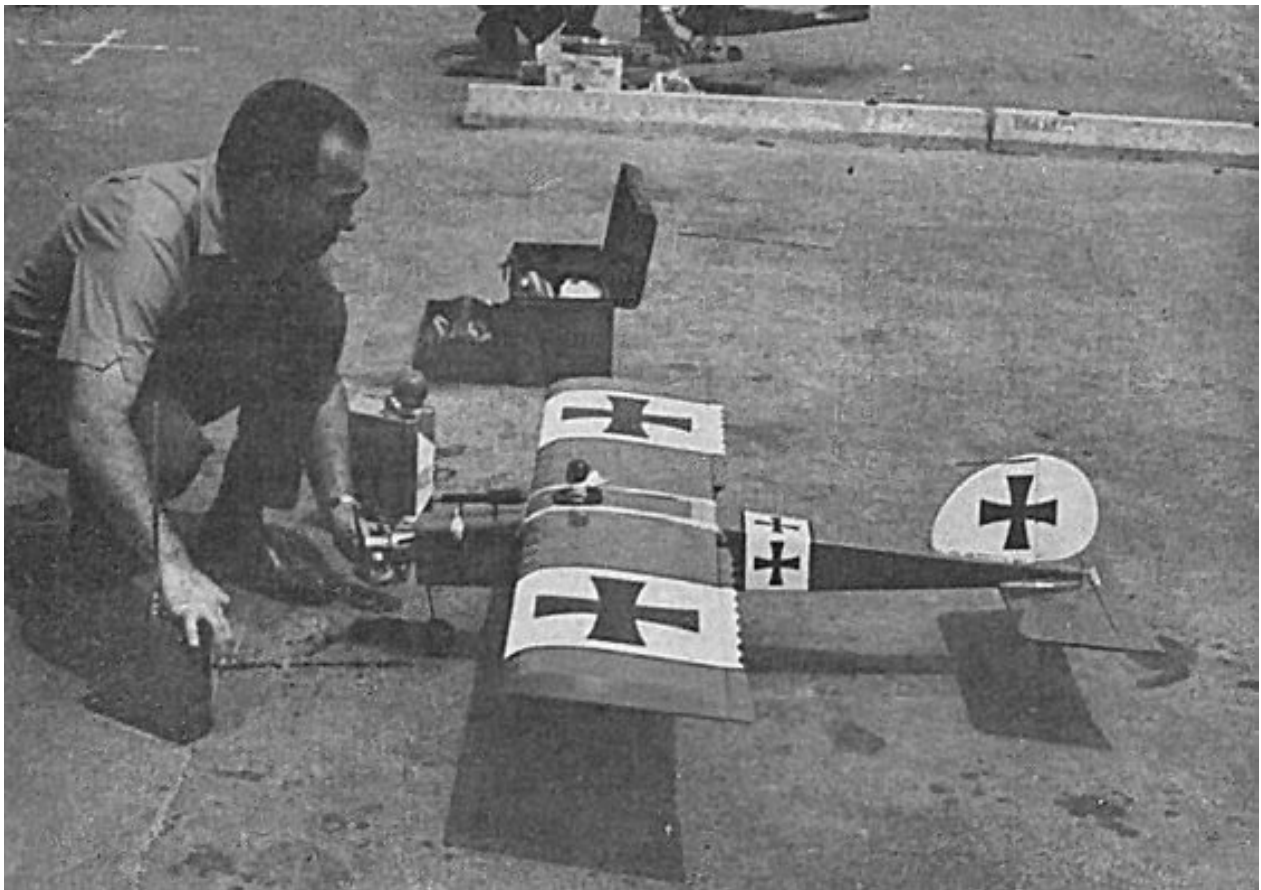

Phil Kraft preparing his Ugly Stik. Note forward position of vertical tail. (GRID LEAKS article.)

Vellum Plan

The model's vertical tail is slightly bigger and substantially further fore than depicted in the plan. You may yourself compare the picture to the plan above. This forward vertical tail position is not mentioned in the article, even though both prototype models shown in the pictures have it. Obviously it was simply the first design, later modified for plan and publication.

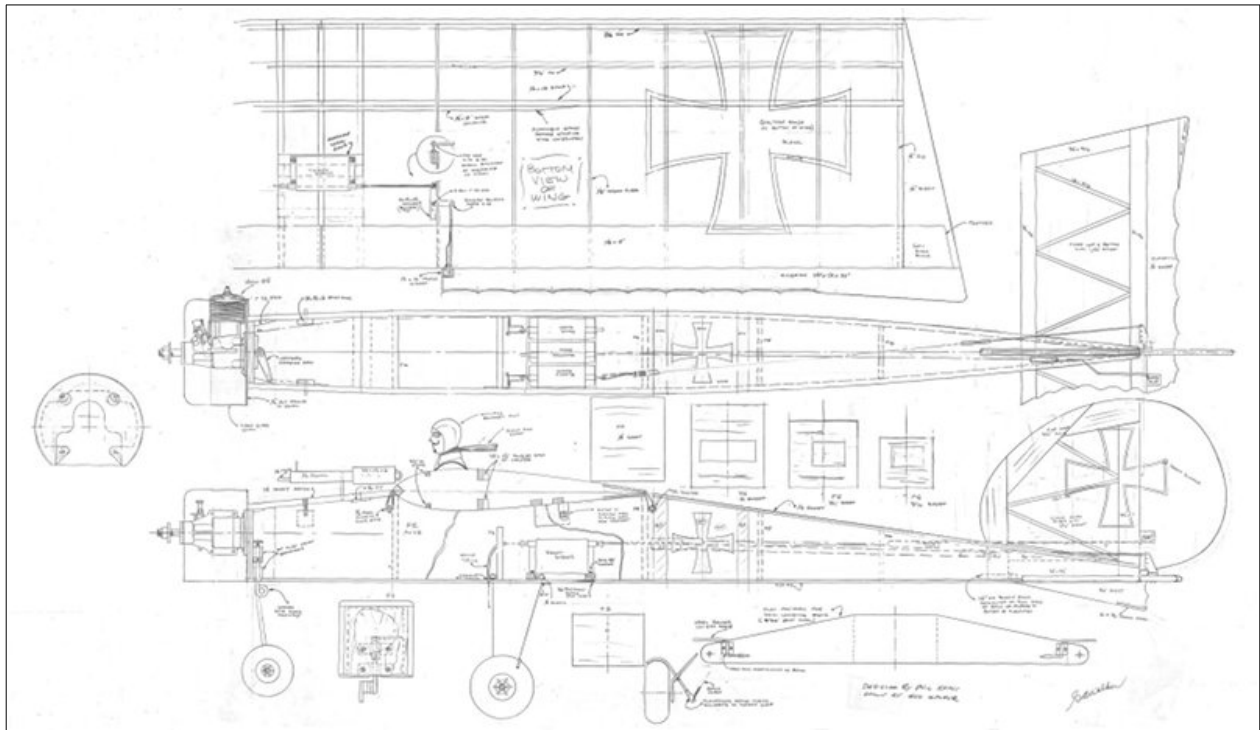

George Walker's vellum plan (full-size at [Outerzone](#)) was the basis for the GRID LEAKS plan.

This is the first plan ever, obviously used for some scribbling as it was called by *Phil Kraft* in his article. But *George Walker* finally made it a proper plan with all necessary details to build a model after it, for it had to be submitted to GRID LEAKS where it has been turned into their plan by *Carl E. Lindsey*.

On the way there, but after the prototypes had been built, the vertical tail must have been changed. Several faint lines remained from cautious erasing and a few gaps in valid lines so it's quite ambiguous. I just dabbled in finding the right or at least the most likely outline that could have been used to build the prototypes.

The next picture shows the result, used for the simulator models. It looks quite reliable in that position; size and shape match those in the picture above. What is more, even the German cross and the hinge line fit. We already noticed that this vertical tail is slightly bigger and substantially further fore, and now we add that it's a bit higher than depicted in the plan.

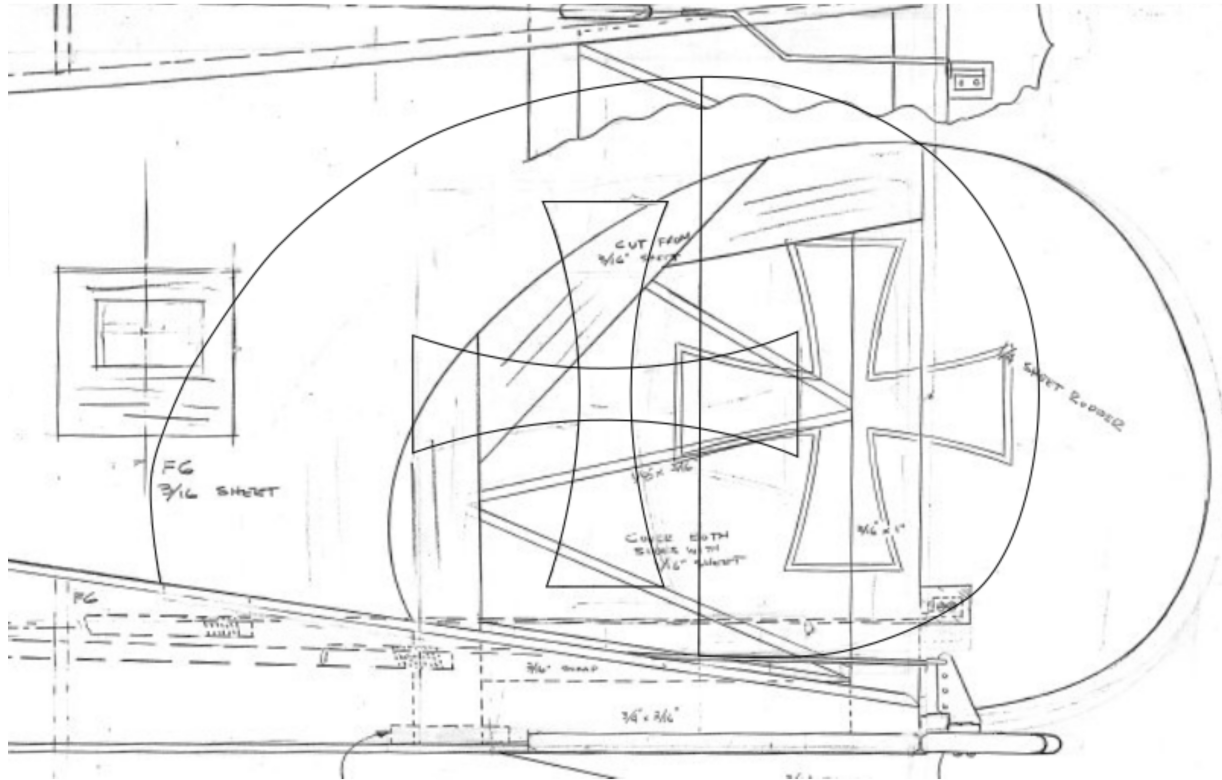

Detail of the vellum plan with an erased vertical-tail outline drawn in again.

You may see those faint lines yourself and assess their validity. Just enlarge the scan of the vellum plan, it is that good and I used it as well. It is at the [Outerzone](#) vintage plans website as an addendum to the GRID LEAKS plan.

Models

Anyway, in the REFLEX model variants the forward vertical tail is rendered not only visually, but also in adjusted physical parameters. But yaw effect and damping are about the same as in the other versions. The forward position is compensated by the bigger size. The whole vertical tail just sits a bit higher, but that has no noticeable effect, maybe because it acts against the existing yaw-roll coupling.

In the simulator, the first prototype (*George Walker's*) has .45 size engine power and quite big control throws so it will fly lively but neither spin nor snap. That should match the intentions expressed in the plan and is the same as the "original" version in the previous chapter.

So the difference is only in the model's appearance. It has the translucent wing, the red fin and white rudder, and the red scarf on the pilot bust like the real prototype. The false ribs are even correct here since the real prototype had them as well.



First prototype (*George Walker's*).

In the simulator, like in reality, the second prototype model (*Phil Kraft's* built by *Dick Kidd*) differs outwardly in that it has an all-white vertical tail and a white scarf on the pilot bust.

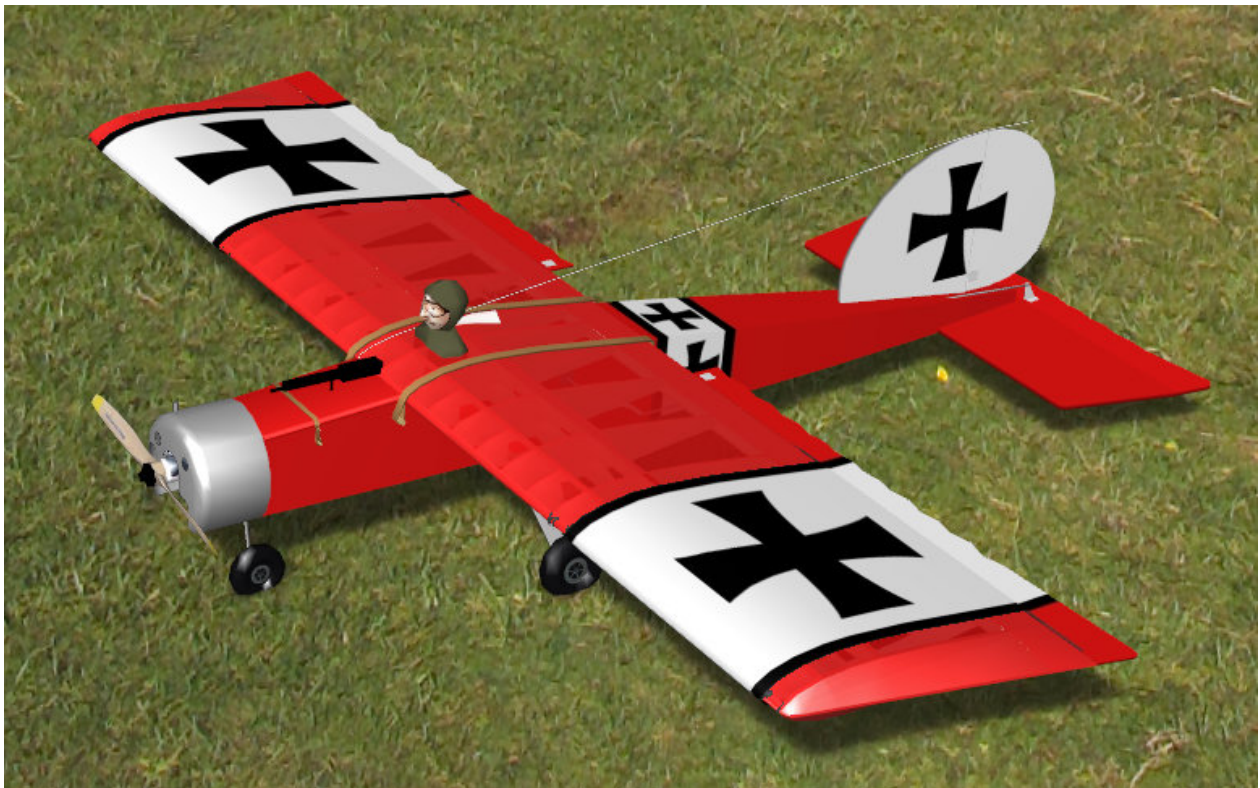

Second prototype (*Phil Kraft's* built by *Dick Kidd*).

But now the drive parameters are set for a .60 engine because *Phil Kraft* recommended .56 to .60 engines in the article and flew them on his own models. So this variant is basically a “wild” version (above) with straight wing.

Not only elevator deflection is now huge because the rudder is no longer an obstacle, also rudder and aileron deflection are even bigger than in the “hot rod” version. The big elevator deflection is really justified here whereas it would not be in the other simulator model variants. Weight is 6 pounds as recommended in the article for best flight characteristics.

Though all other versions can have only 30 degrees elevator deflection, they might spin and snap quite well if only the center of gravity would be quite far back. This variant spins and snaps well, but due to its big elevator deflection. Snap rolls turn out well only to the left, though, assisted by the propeller torque. I have no clue if this behavior observed in REFLEX is realistic.

Anyway, the real first prototype’s behavior is shown quite well in the original maiden-flight movie shot by *George Walker* himself. It’s just a low-resolution 50-years-old 8mm movie, transformed into a video of slightly too slow speed ([at YouTube](#)). To show this .45-powered model at correct speed and in more detail, both in the air and on the ground, a demonstration flight in the simulator has been shot in HD ([at YouTube](#)). To watch it in REFLEX, hit F9, and under “Aircraft” select “Das Ugly Stik prototype”.

Sources

Along with the article and the full-size plan from GRID LEAKS, *George Walker’s* autographed original vellum plan (scanned PDF) is available for download from the [Outerzone](#) vintage plans website.

There, in the “About” for this plan, *Marc Bird*, who submitted the plan copy, quotes *Danny Lutz*, who built most of *Phil Kraft’s* models. He told that an Enya 60TV was used on *Phil Kraft’s* Stiks.

George Walker’s Early Sixties R/C 8mm movies, especially his Das Ugly Stik prototype’s maiden flight (done by *Jim Jensen*), are in a playlist [at YouTube](#).

As a supplement, I recorded a demonstration flight with the prototype model in the simulator. A HD video of this demo flight is [at YouTube](#) as well.

Chapter 6

Test Bed

Dubbed Box-Fli, Square Stik, Nasti-Stik, Ugly Stick.

Before the model became what we know as Das Ugly Stik, it must have had a turbulent life as a test-bed for the all-new proportional radio control developed by *Phil Kraft's* company in 1964 and 1965. Since the test flights took place on much frequented model flying fields, many – and some well-known – model fliers got to know it and found it even uglier than the Kwik-Fli (Mk. I that is).

That's why they dubbed it "Ugly Stick" or "Nasti-Stik", bantering *Phil Kraft*. Also the name "Square Stik" has been mentioned, but that could have been used later to distinguish it from Das Ugly Stik as we know it. The latter had a round vertical tail, fancy wing and stab tips, and scalloped ailerons and elevator; the former was completely "square". Allegedly, *Phil Kraft* originally named it Box-Fli and that's what I'll just use as its distinguishing name here.

Inference

There is no report about this model in any publication, only *George Walker's* recollection of that boxy ugly stick he turned into Das Ugly Stik. He took a picture of his prototype to plot the outlines, called just Ugly Stick by him.

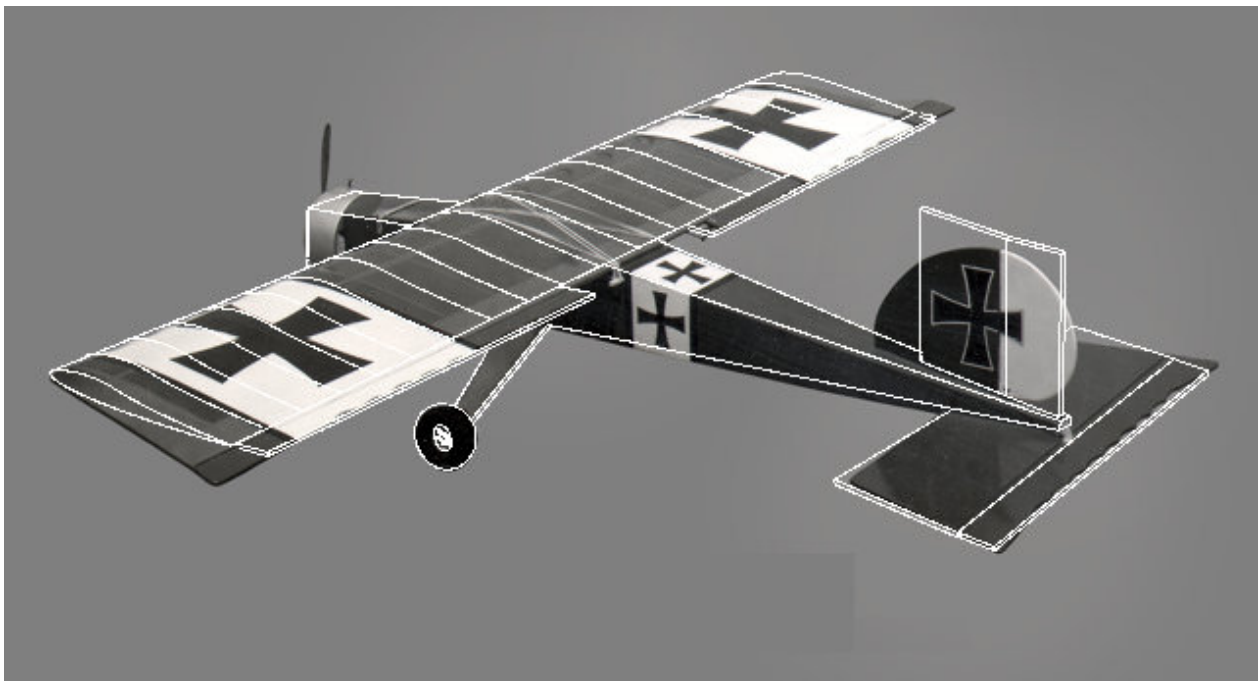

Both are virtually the same model, the test-bed just without any frills or decorations – utter simplicity. They had even the rudder in front of the elevator, just like Kwik-Fli Mk. I and II had as well. Obviously, *George Walker's* idea was to pretty up the model to make it acceptable and even interesting for many interested modelers who were eager to benefit from its outstanding qualities as a trainer model. (I think it's qualities just as a fun model have been realized only later.)

Model

To adhere to the “living history” ploy, the progenitor of Das Ugly Stik had to be rendered as a simulator model as well. As the picture above suggests, it is just a simplified prototype version. My impression is that the wing still looks like drooping, even if it's square, so it has to be not only the “Fokker-type” planform what makes for that but also the straight wing by itself.

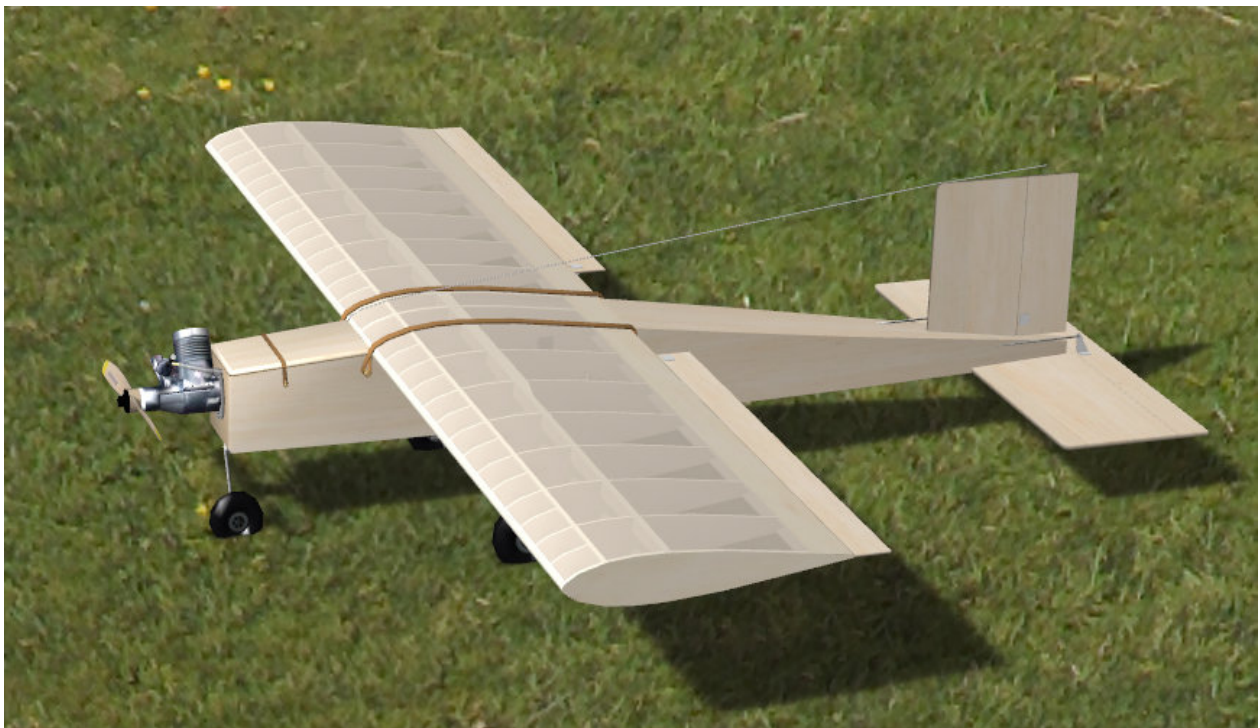

The engine is rear-mounted with an aluminum backplate, as was typical for *Phil Kraft's* models. It's mounted with the cylinder not horizontal or vertical, but “at an angle for proper fuel flow level” (*Phil Kraft's* Kwik-Fli Mk. I article). There's no other reason for this than that it's seen on the contemporaneous Kwik-Fli Mk. I and II and Bar-Fli models (except that the engine simulator model's right bottom side looks awkward and is invisible that way). The prototypes of Das Ugly Stik as well as the Jensen kit models had the cylinder horizontal, and one of the backplate mounting screws was used for one of the nose gear Nylon bearings at the same time. But other than these I never saw pictures of models with the engine mounted that way.

The “paint scheme” is an attempt to give the impression of natural-colored (or white) silk and raw balsa wood, both painted with clear dope. That’s because *George Walker* thinks the real model was just so. And that even matches what *Phil Kraft* wrote in GRID LEAKS magazine: »On the original, only the wing was covered with silk. On the balance of the wood surface I merely utilized a good dope.«



Photos of a real model (a Blue Angel) finished that way have been used to gather suitable textures for this simulator model. On the ground, like in these two pictures, the impression is even far better than in the air. That’s in the simulator, of course, but I believe it’s pretty close to the real thing. This is what the Box-Fli at least *could* have looked like.

Of course, the “virtual” Box-Fli is set up like the prototype, with the more forward and bigger vertical tail (above). The engine is supposed to be a .60 as reportedly used by *Phil Kraft*. The control throws are set to 30 degrees for rudder, 30 degrees for elevator (because the short wing needs much pitch), and 18 degrees for ailerons.

Despite the short vertical tail moment arm, and thanks to more area, rudder effect and yaw damping are well sufficient. Due to missing tips, the wing is even stubbier. The smaller aspect ratio makes for slightly different aerodynamic coefficients, but that is hardly noticeable.

There’s a demonstration flight in REFLEX XTR² showing the model in action and at close range. In REFLEX, hit F9, and under “Aircraft” select “Box-Fli” to watch it. A HD video of this demo flight can be watched [at YouTube](#).

Sources

There are virtually no sources.

There's *George Walker's* strong recollection, backed by original material.

In the "About" for the GRID LEAKS plan at the [Outerzone](#) vintage plans Web site, *Marc Bird*, who submitted the plan copy, quotes *Danny Lutz*, who built most of *Phil Kraft's* models. He told that an Enya 60TV was used on *Phil Kraft's* Stiks.

In [a post](#) in the Ugly Stik thread at RC Universe, someone told that *Phil Kraft* originally named the model Box-Fli. Only later he followed a friend's (probably *George Walker's*) suggestion, modified the model to look like a Fokker Eindecker, and renamed it Das Ugly Stik.

The demonstration flight showing the simulator model in action and at close range may be watched [at YouTube](#).

Chapter 7

History

Test Bed, GRID LEAKS Magazine, Jensen Kit, RCM Magazine.

For ten years, this chapter was a mere addendum to the actual article about my Ugly Stik models for the REFLEX XTR² simulator. Meanwhile so much information and material about details and history accumulated that it had to be turned into a full-blown history chapter. And since the simulator models are meant as “living history”, they are instrumental in illustrating this history. Consequently, both documents have been joined into this one.

The history of Das Ugly Stik as we know it starts in 1966. Allegedly on requests for plans, *Phil Kraft* published the famous first plan in the May-June 1966 GRID LEAKS issue, along with pictures and a terse article. Shortly after, his friend *Jim Jensen* brought out a kit, allegedly on demand as well. And in a way, *George Walker* was the originator of both events.

As he told me, he was close friend to *Phil Kraft* and worked a lot for him. He is a graphics designer and did all of *Kraft's* advertising, including the photos. He did all their manuals, the lettering for the transmitter nameplates, the signets, and designed even their PCBs until the double-sided boards came up. They lived next to each other and sometimes flew together.

He must even have attended the 1964 maiden flight of *Phil Kraft's* test-bed for their all new proportional R/C under development. Allegedly, the model was called Box-Fli for its extremely simple and boxy shape. Eventually he burst out “that is one ugly stick”, what seems to be an American English idiom (see [Wikipedia](#)). Obviously he was not the only one to react this way, but he went much further.

He asked *Phil Kraft* for a blueprint and used it to make a version resembling a Fokker Eindecker, or at least in parts (especially vertical tail) an Albatros, both German WWI airplanes. A characteristic livery and some frills were part of this design, as well as the German sounding name **Das Ugly Stik**. He built such a model and showed it *Phil Kraft* who liked it and asked for an own one. *Phil* proposed *Dick Kidd*, who was good at that, for building it, and so he did.

Jim Jensen got involved and took over to produce a kit. *George Walker* didn't like the model's droopy wings and asked *Phil Kraft* to apply some dihedral. *Phil* agreed and *George* drew a completely new plan for *Jensen*, who wanted further modifications, anyway. Meanwhile, *George's* original vellum plan had been turned into the GRID LEAKS plan by someone else (*Carl E. Lindsey*).

That is the history of Das Ugly Stik in short, now for the long version...

Origin

Basically, this model's origin is in the dark. There are few indications and meager contemporary witness reports. Still some insights are obtained by conclusion:

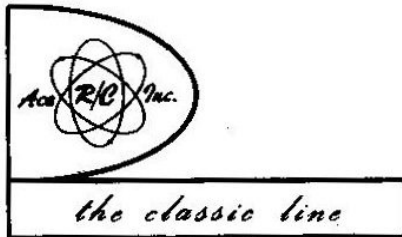

Eric Wildermuth not only had the original article and plan he used to build several Stiks, he also found an old Ace R/C ad remembering the derivation of Das Ugly Stik from a Square Stik, as *Phil Kraft* told in his article.

In [this post](#) in the Ugly Stik thread at RC Universe, someone told that *Phil Kraft* originally named the model Box-Fli. Only later he followed a friend's (should be *George Walker's*) suggestion, modified the model to look like a Fokker Eindecker, and aptly renamed it Square Stik and finally Das Ugly Stik. The post sounds credible and the name would fit in the line of names *Phil Kraft* gave his designs. There's no real evidence, but I would believe it.

By the way, the GRID LEAKS article tells »The plans were finished on a Sunday afternoon some two years ago.« Regardless of the original name, that means the design is actually from 1964. *George Walker* drew the first vellum plan and built the model shown in the GRID LEAKS article and on the issue's front page only in early 1966, and drew the Jensen plans even later.

The [post](#) mentioned above also tells that »During the development of the KP-4 Proportional system Mr Kraft would close the shop and the whole crew would drive (about 3 blocks) to Whittier Narrows to watch him fly. This was in 1964.« The poster was a crew member since August 1964 as he told in [another post](#).

DAS UGLY STICK



The Ugly Stik was originally the Square Stik. By adding scalloped ailerons and scalloped elevators, and adding a semi scale rudder, this .45 to .60 powered proportional testbed resembled a Fokker-Eindecker World War I plane.

Used by *Phil Kraft* as a testbed for new proportional gear, this one has several Class III wins under its belt. If you are looking for a plane that is easy and fast to build for your proportional, this is your baby. You can use it in either the square configuration or in the semi scale configuration.

The [Radio Control Hall of Fame](#) has a comprehensive Kraft story which tells that Kraft moved production from his garage to a leased plant in [2519 Lee Avenue, South El Monte](#), probably in 1962 or 1963 since he started production in 1962 and ran his first ad with the new address in October 1963. According to the Radio Control Hall of Fame, there were ads with this address until 1965, and probably in 1965 the production moved again to [2466 Seaman Avenue, South El Monte, Ca](#). In fact, there is even an ad (for the new KP-6) with the Lee Avenue address just at the back cover of the very May-June 1966 GRID LEAKS issue that introduced Das Ugly Stik.

Anyway, that matches what the poster tells. In his other post he says »After Don Mathes left, the company began shipping KP-4 proportional radios and moved to a larger building.« The Radio Control Hall of Fame tells that Kraft intended to launch his first proportional system, which was curiously called KP-4 by ACE, in April 1964. The ads disappeared in the summer due to still unresolved problems. At the very end of 1964 the "real", final KP-4 was announced and production started in June 1965.

That means at least in 1964 and maybe even in early 1965 *Phil Kraft* was experiencing all technical problems of the all-new system in his test flights at the [Whittier Narrows model flying field](#) ([San Gabriel Valley Radio Control League](#)) while the operations were still in Lee Avenue.

Finally, in early 1969 they moved again to a much larger factory in [450 W California Avenue, Vista](#), but in the important years from the development of the break-through KP-4 to the great Worlds and Nats wins *Phil Kraft* flew at Whittier Narrows. The model flying field as well as all three factory buildings obviously still exist so you may see them at Google Maps and Street View.

The photos of Das Ugly Stik, and of Kwik-Fli and Bar-Fli as well, which have been published in magazines, probably all have been shot at one of the flying fields in the area, especially the [Van Nuys R/C Field](#) ([San Fernando Valley Flyers](#)) at the Sepulveda Basin, or at the Whittier Narrows model flying field, and later also in front of the Seaman Avenue factory.

By the way, *George Walker* remembers that, when *Phil Kraft* did the test-bed's maiden flight, he was there as well as *Kraft's* associates *Don Mathes* and *Doug Spreng*. Yet no photos (or even film) have been shot because nobody thought such a simple and ugly model could be worth it.

You may imagine how it was back then with the basic Box-Fli without any frills (as the mentioned poster told again in a [new post](#)). It was meant as an expendable model, just a test bed. Maybe *Phil Kraft* was influenced by *Zel Ritchie* who years before had used a purpose-built test bed, which he called "the box" (see [this post](#) at RC Universe and the very end of [this one](#)). And it's even possible that he had Das Ugly Stik embellished and kitted only to have a source for inexpensive test beds flown by sponsored pilots. After all he had it built and flown in numbers to test-fly all new proportional R/C sets.

Glimpse

In June 1965, even one year before the May-June 1966 GRID LEAKS article introduced Das Ugly Stik, RCM magazine published an article with plan for a rudder-elevator beginner model called the Royal Coachman. *Don Dewey*, RCM's editor, designed it with a remarkable resemblance to the Ugly Stik concept in its initial form. The whole June 1965 RCM issue is available in the [RCLibrary](#), the plan and the article are at [Outerzone](#).

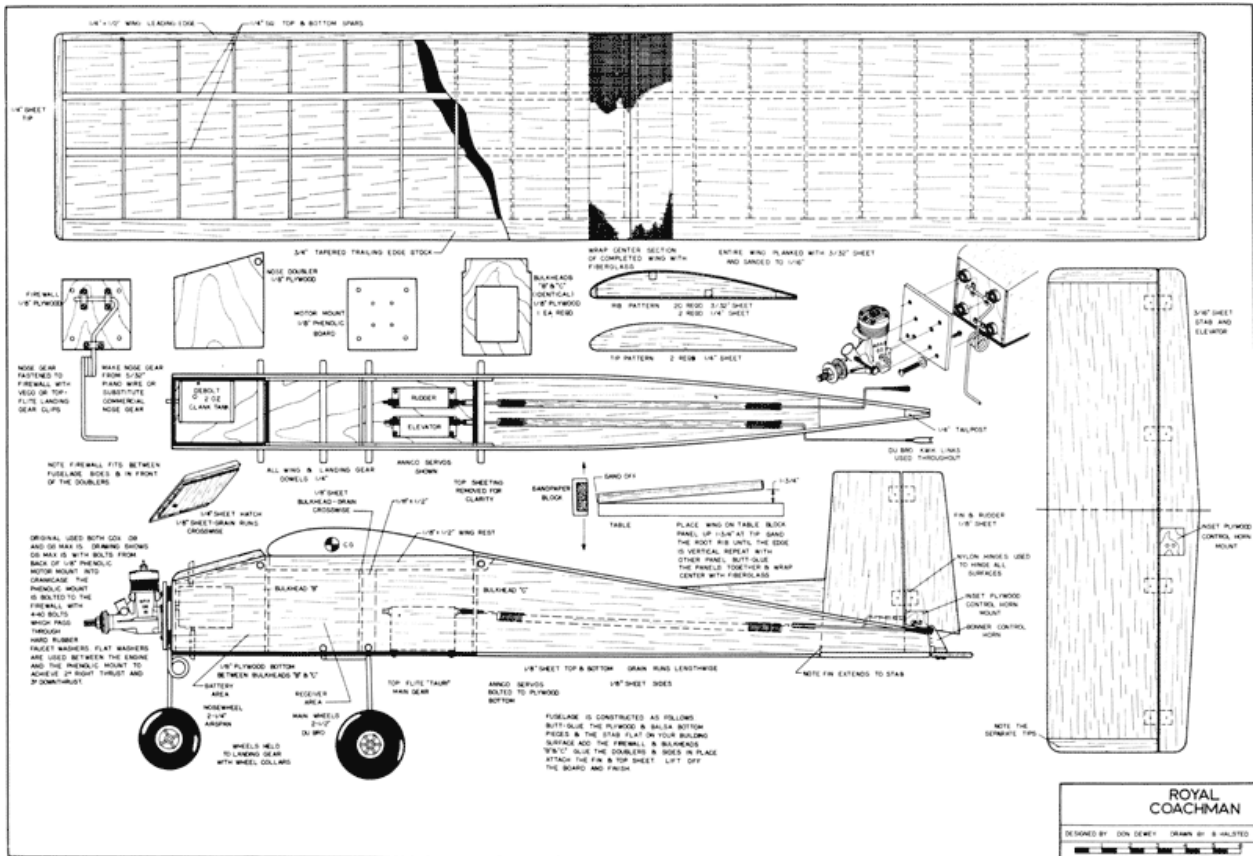

When I saw this plan for the first time I burst out: "Lil' Ugly Stik!" That is a "Box-Fli" or "Square Stik" in its original form, just smaller and not with ailerons but with dihedral instead. The flat-bottom wing is appropriate for a beginner model and makes building even easier, as does full sheeting. The model is quickly built, cheap, and thus expendable – just like Das Ugly Stik.

Only few people knew the "Box-Fli" or "Square Stik" in 1965, but *Don Dewey* was among them. There was still no Das Ugly Stik as we know it, let alone a publication about it to which *Don Dewey* could refer. So he just tells that the fuselage design was "borrowed" from *Phil Kraft*, who used it on a design they had dubbed the "Nasti-Stik". Duh!

The aerodynamic “design formula” may be taken from *Chuck Cunningham’s* “R/C Design Made Easy” in the March 1965 issue of RCM ([RCLibrary](#)), but the “Box-Fli” or “Nasti-Stik” conforms to this formula as well. And it’s about the whole arrangement with wing and empennage (and engine as well as landing gear, for that matter), not the fuselage alone. The overall concept is the same as that of Das Ugly Stik. Who was the inventor, or was it just in the air? (Compare this [post](#) at RC Universe.) Obviously, *Phil Kraft* didn’t care, and good ideas should be free, anyway.

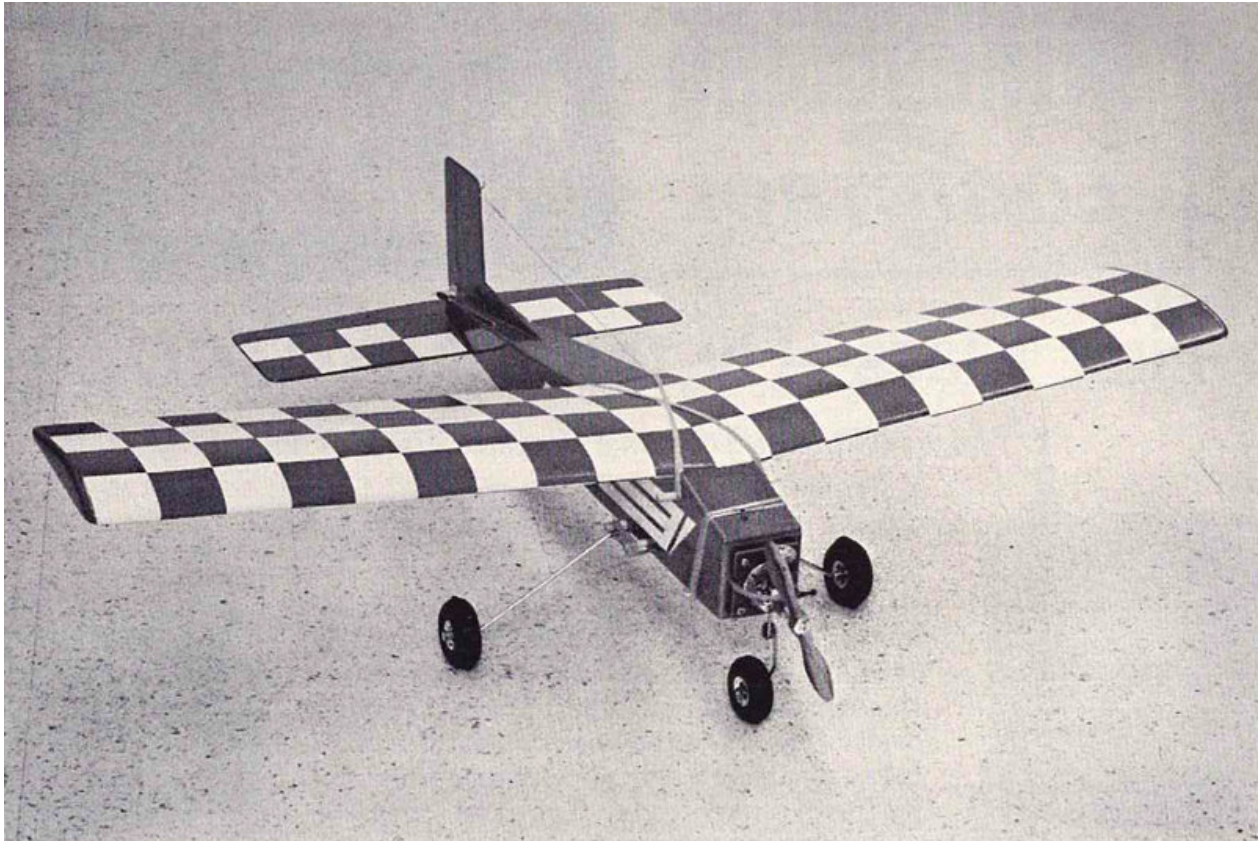

Fin, rudder, and elevator have been slightly tapered, and there is a dorsal fin. The model got a nice paint scheme that makes it look rather friendly, after all it’s meant as a beginner model. It looks quite racy as well, after all it can be “a fast moving ship that’s quite a handful” (RCM article). Just like Das Ugly Stik, it can be mild or wild, depending on engine power (a small .09 or a .15, which is not big either, in this case).

It’s a nearly complete coincidence: A boxy, functional model that is quickly built and flies very well is prettied up to please the beginner and the fun-flier alike, who just take different engines. Only the notion of a racy sport model is dissimilar from that of a grim German fighter. The public, the RCM magazine readers that is, got a glimpse of the Ugly Stick (or “Nasti-Stik”) and what it could be turned into, but without even knowing it yet.

Metamorphosis

What *George Walker* recollects as original “Ugly Stick” is utterly simple:

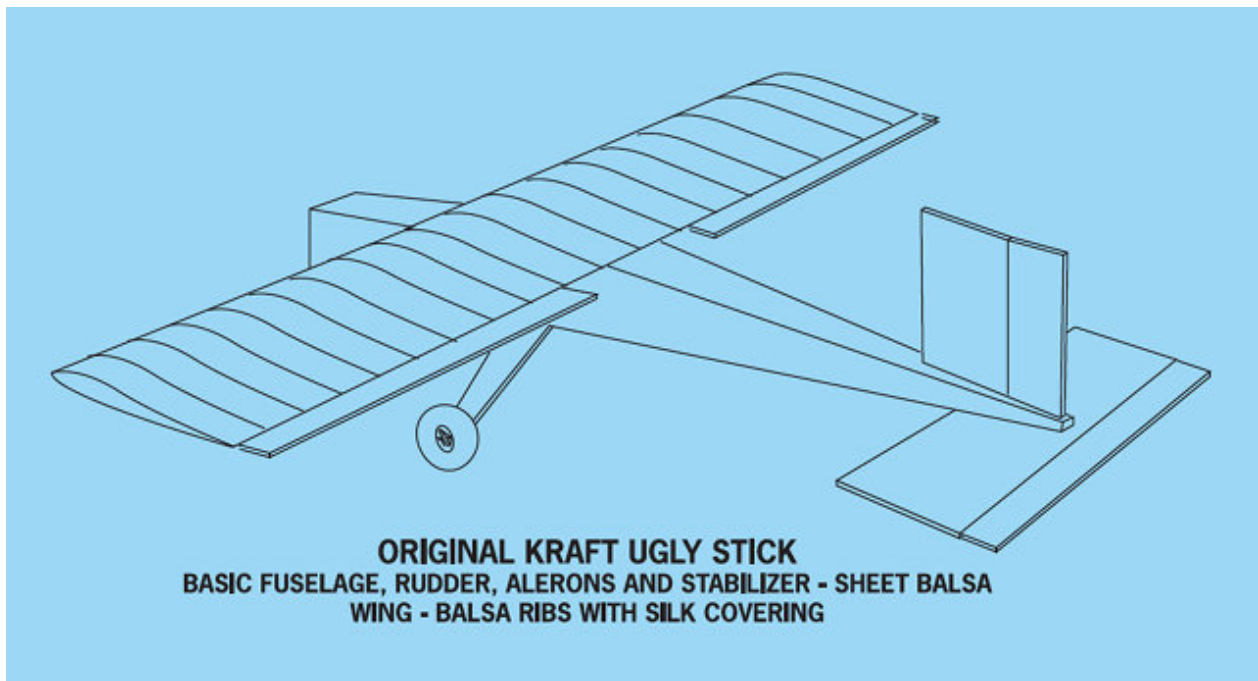

He drew this sketch as an overlay to a photo of his prototype model (overlay shown above in chapter Test Bed). The following picture is a scan of the original photo. (Notice its quality and the absence of pilot and gun.) That’s how he turned the “Ugly Stick” (nickname) into Das Ugly Stik (official name):



50 years after the event, this is kind of reverse engineering *Kraft’s* model from its mutation. Still it’s quite clear and conclusive.

And quite obviously *George Walker* was reminded of a Fokker E.III Eindecker (monoplane). [Wikipedia](#) has pictures that show the characteristic planform of wing and stabilizer. The characteristic engine cowl is visible as well.

George explicitly mentioned that he was inspired by an Albatros D.III biplane regarding fin and rudder. [Wikipedia](#) has a picture showing the low and long shape as well as the paint scheme with white rudder but colored fin. There were later versions with the round rudder the Ugly Stik got. And the rudder is in front of the elevator, what matched the arrangement on *Kraft's* model.

George chose red color because that had become widely known during WWI. The German ace *Manfred von Richthofen* had red-painted airplanes which is why he had been called the Red Baron. And the red color made for a striking look of Das Ugly Stik. The prototype model was covered with red-dyed silk and painted with clear dope and that's why the wing is translucent.

The German insignia on wings and fuselage were taken from the Fokker and other examples, the black pinstripes have been added. The German cross on the vertical tail seems to be taken from the Albatros like the tail itself.

The Fokker type engine cowl for the model was made from fiberglass over a wooden plug and cut to shape. The plywood back plate was epoxied to the cowl and the whole thing painted with silver dope. The original Fokker cowls were unpainted aluminum sheet metal after all. The cowl is one of two things *George* still has from his Das Ugly Stik prototype.

The other one is the pilot bust. It had been made by [Williams Brothers Model Products](#), and obviously it's still available. It was painted including goggles and a mustache and got a scarf made from a scrap piece of red covering silk.

A machine gun just belongs to a Fokker Eindecker, and that of Das Ugly Stik was made from a piece of wood, a dowel, tubing, and wire and had even a sight. Today, there are a few machine gun kits by Williams Brothers, but back then they were not available yet, and the gun was easy to make.

Finally, the name Das Ugly Stik emphasized the overall German appearance. The name Ugly Stick had been coined before, and the spelling Stik (instead of Stick) made it kind of different, like many model names *Phil Kraft* used. *George* added "Das" (meaning "the") for even more German appearance.

This appearance was enthusiastically received and loved by many modelers. I think it's something like macabre Halloween symbols, like witches, skeletons, or ghosts. By all means, the model was not meant as a seriously threatening, aggressive German fighter. After all it wasn't a scale model but an ugly model as a fitting basis turned into something like a flying Halloween witch. It was made with love, and with several realistic details, so it can really play its role and send pleasant shivers down your spine. Even its flight characteristics fit as it can be recklessly "knocked around". This model was no longer a test-bed and trainer alone – it promised to become a fun-fly hit.

GRID LEAKS Article

Jim Jensen, who was designated to produce a kit and was a very good pilot, did the maiden flight with *George Walker's* prototype. *George* says he was just too nervous and did only the third flight. Later, *Phil Kraft* flew his own prototype model built for him by *Dick Kidd*, who was a very good builder and had built an exact copy, except an all-white vertical tail (and white scarf).

Photos were shot of *George Walker* posing with his model (by a friend with a 4x5 camera), his model on the ground, and *Phil Kraft* readying and flying his model (by *George* himself). The maiden flight was even shot on 8mm film (by *George* as well) with a special wide-screen lens (movie [at YouTube](#)).

Phil Kraft wrote a short, witty, and – just for that reason and in itself – interesting article. This, the photos, and a copy of *George Walker's* vellum plan were committed to GRID LEAKS for publication.

GRID LEAKS was a bi-monthly magazine published by ACE R/C Inc., a well-known powerhouse of the R/C industry in the 1950s and 1960s. A good characterization is in a special *Kraft* web page of the [Radio Control Hall of Fame](#) (search for "Meet The Runges"). They were friends to *Phil Kraft* and sold his R/C products until proportional came.

So it was consequential that they published the Ugly Stik article and offered the full-size plan in their plan service. I think they wanted to have it in their catalog because big demand was in the offing, and they also needed to promote a kit. The article and even the plan were kind of an advertising blitz.

I think that's why they just got a copy of *George Walker's* provisional plan and turned it into a formal plan. It was not really meant as a plan for building (originally being a draft for the prototype), even if they presented it that way (after all it was usable). Just as well could *Phil Kraft's* article not be seen as a building article, even though there were some building notes.

Actually, article and plan just showed how interesting the model is and how easy to build. Of course, the seasoned modelers of the time needed not more than this and built their Ugly Stiks even from the small two-page article plan alone. But Average Joe preferred a kit with full-size plan and some building instructions (and got all that from *Jensen* shortly after).

But let's have a look at *Phil Kraft's* article to see his original intentions and appreciate his achievement. The following is the original article, as scanned in high resolution from a copy of the May-June 1966 GRID LEAKS issue provided by *George Walker*. If you manage to read the text (some enlargement may help), you – as me – might find some things remarkable. I refrained from typing the text. Otherwise you, the esteemed reader, might think I'm telling tall stories in it. *Phil Kraft* himself tells the story of Das Ugly Stik as if it were nothing unusual.

RADIO CONTROL and Model Aircraft WORLD



VOL. 7, NO. 3 MAY-JUNE 1966 35 CENTS



**EIGHTH
YEAR OF
SERVICE**

IN THIS ISSUE
• Phil Kraft's new multi
—Das Ugly Stik • Micro
Proportional Two-Axis
Control • Letter from a
Yachtsman • New Prod-
ucts Reviewed • 9V
Rudder-Only Pulser

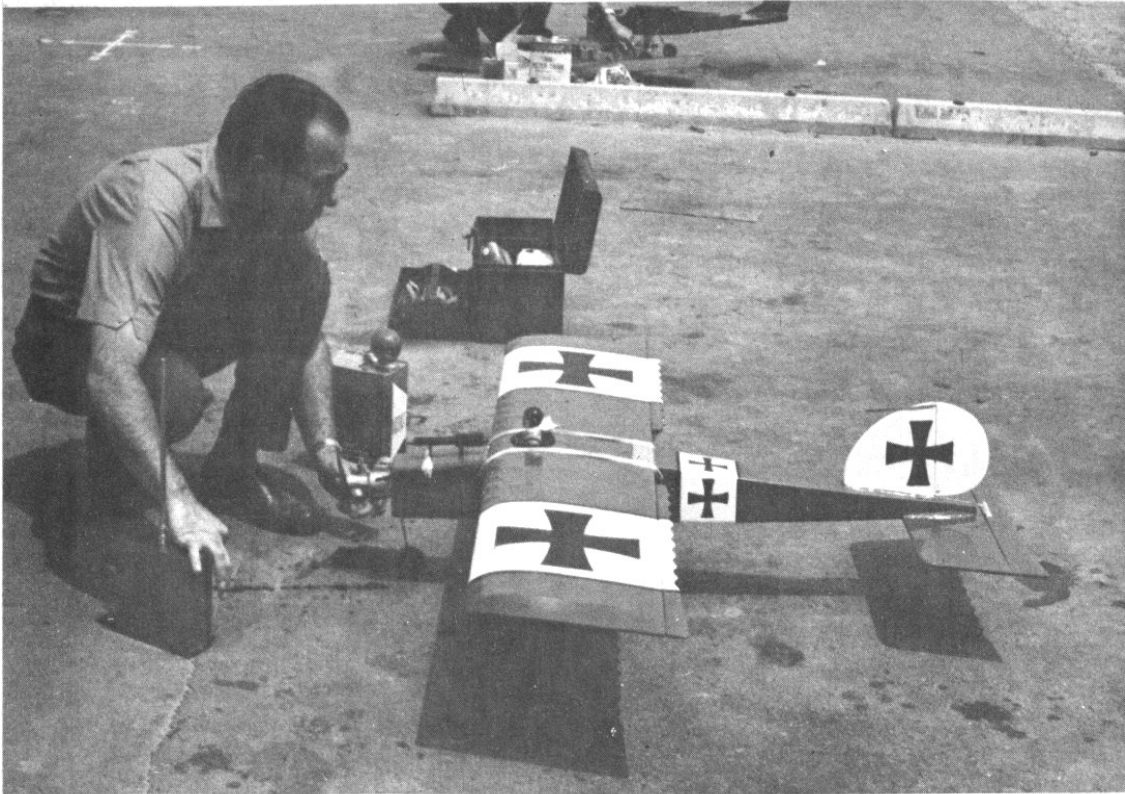

The author-designer readies the ship for starting. The plane is a simplified version, as George Walker's model, right, indicates.

Das Ugly Stik

Something different in multi trainers with full pattern ability.

By PHIL KRAFT

THE ORIGINAL CONCEPT of the Ugly Stik was to design a radio controlled aircraft which could be built in an absolute minimum of time. Its purpose was towards a flying test bed for new proportional control developments and an all-around shop airplane which could be used as a loaner for visiting flyers, testing repaired equipment, and any use which required an airplane which could be considered as expendable.

In the original form, the Ugly Stik was completely square. All surfaces were merely cut out of standard sizes of wood with no curves or frills whatsoever. The plans were finished on a Sunday afternoon some two years ago. A visit to our local hobby shop was made at approximately 4:30 to purchase the wood and other necessary materials. Taking time out for Sunday dinner, still the framework was completed by

10:00 o'clock that evening. Two more evenings were required for covering and doping, and on Thursday of that week, the ship was first flown.

Obviously not much time was taken in sanding or painting. This was to be an expendable, utility airplane. As with most straight-forward functional designs, the Ugly Stik proved to be an excellent flyer. It was extremely stable, very easy to fly, and quite capable of contest performance. I am not sure who first applied the name Ugly Stik to the design, but whoever it was certainly applied a descriptive name. Wherever it was flown, I was subjected to a great deal of kidding about finally having developed an airplane even uglier than the Kwik Fli. There were also a great many requests for plans, particularly among the newcomers to radio control who wished for an easy-to-fly, rugged, expendable air-

plane to learn on—which this surely is.

There was in this early square design something suggestive of a World War I type aircraft. As a joke with assorted scribbling on the plans, we came up with a design vaguely reminiscent of the Fokker-Eindecker. The results were perhaps no less ugly, but did tend to produce a design with a certain amount of charm and appeal. Certainly it never fails to create a great deal of attention among the spectators at the local flying field.

Performance-wise, it of course can not be classed as an all out competition Class III model. However, it is certainly capable of winning contests in the hands of a good flyer. While the design has not been used a great deal for contest work, it has several wins to its credit in Class III. Its main virtue is as a trainer for the beginner in proportional (Continued on page 6)

In the caption, "right" means the next page (not numbered, has to be 5):

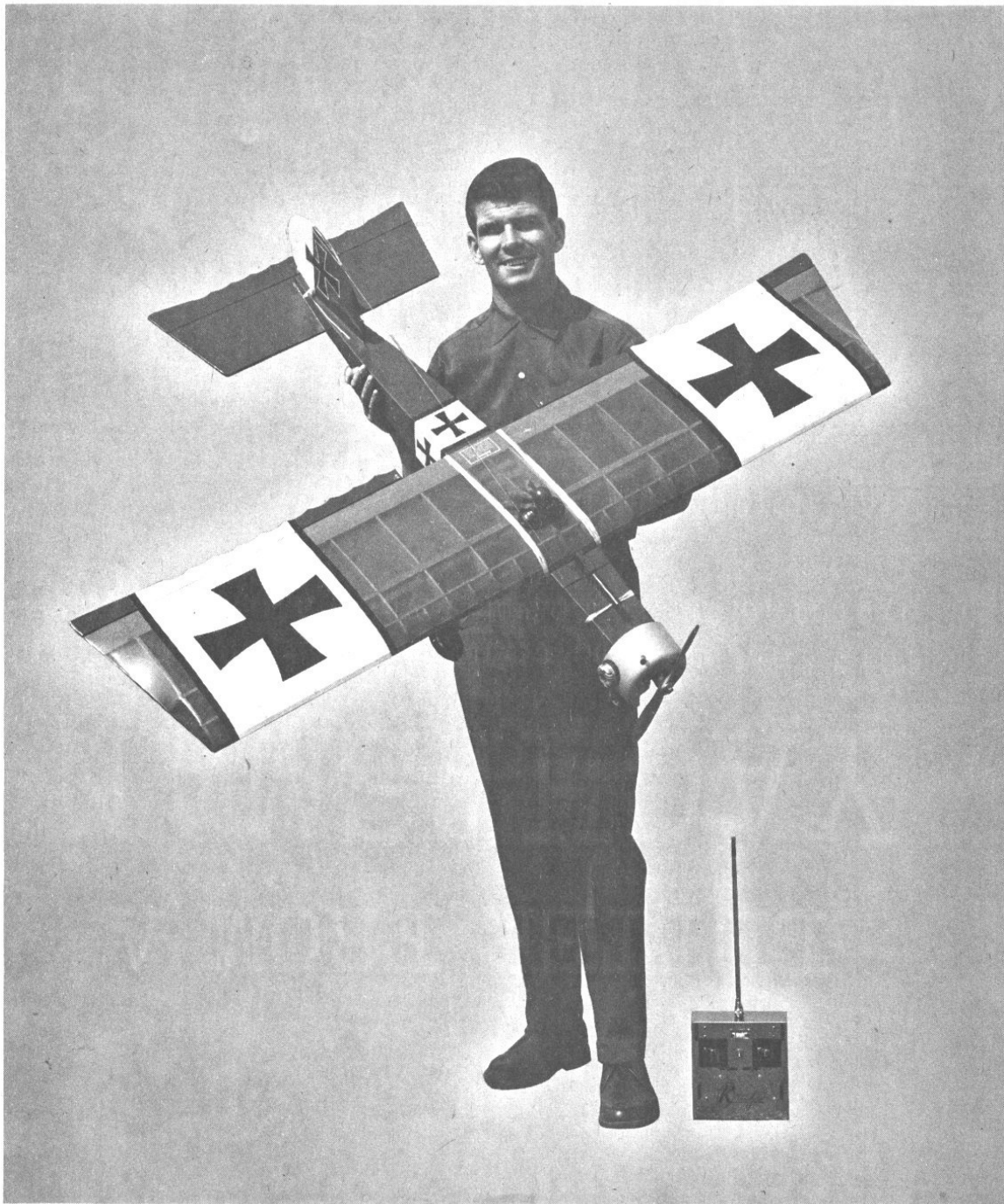

This is page 5 (*George Walker* at age 38).

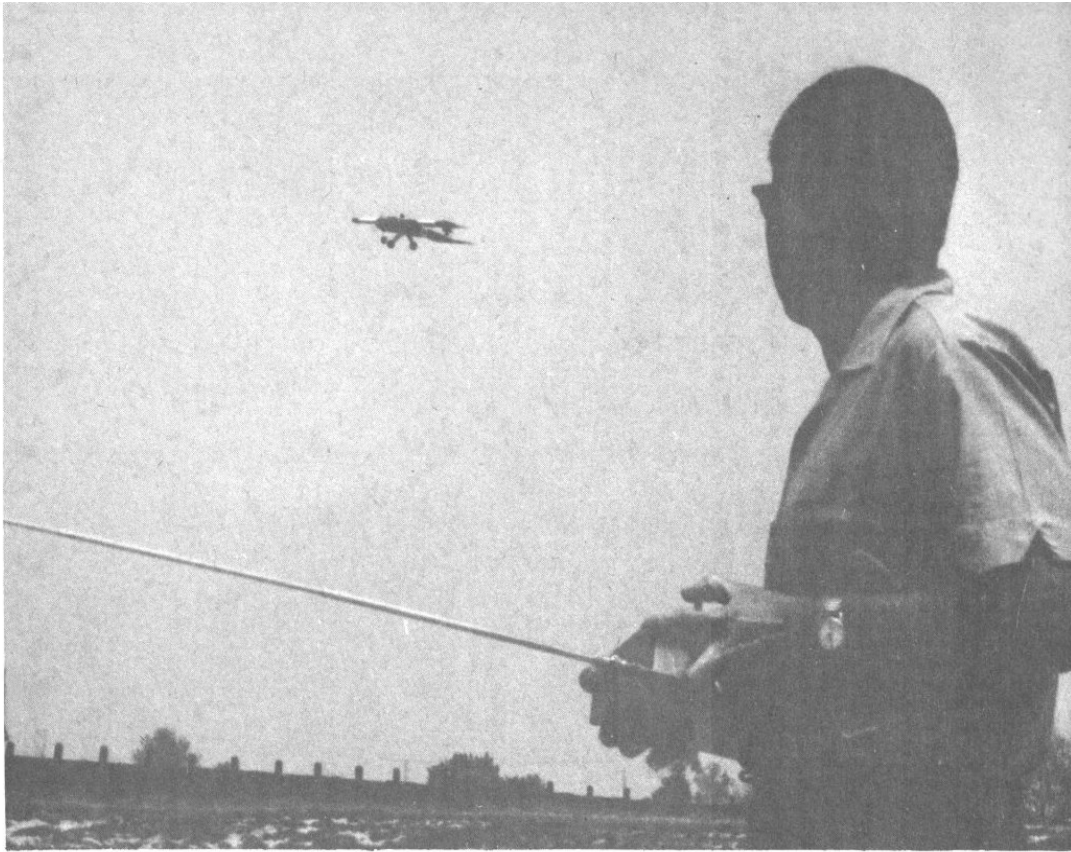

Phil executes fly-by for benefit of lensman. He built basic frame in less than five hours, covered and doped in two more evenings.

Das Ugly Stik

(Continued from page 5)

control. I have always felt that is a waste of time for newcomers in our hobby to spend over a hundred hours on an elaborate Class III design to learn on. Inevitably, unless the beginner is of remarkably unusual talent, he's going to have minor or major accidents due to misjudgment in learning. Therefore the Ugly Stick fits the requirements perfectly as a trainer. It is about as simple as possible to construct. As stated before, it is rugged and very easy to fly.

For those merely wishing an expendable trainer, the scalloped strip ailerons, elevator and rudder can be dispensed with, and just straight forward construction used. However, the details toward making an early type of German World War I airplane add only an hour or so to the building time and create quite a novel appearance.

Construction is so straight forward that very little in the way of detailed step by step instructions are required. The grade of wood used throughout is not particularly critical as the flying weight can vary from 5¼ to 6½ pounds without materially affecting performance. Actually the Ugly Stik flies best at about 6 pounds using .56

to .60 engines. This gives lively flying.

The fuselage is absolutely straight and flat on the bottom. The first step in construction should be to cut the 3/32" plywood bottom sheet as indicated on the plans. Pin this to a flat work surface, along with the 3/32" bottom planking which is spliced to the plywood nosepiece. The fuselage sides are cut from ¼" sheet balsa as well as the bulkheads with the exception of the ¼" plywood firewall. Cement the bulkheads to the bottom sheet and then merely position the fuselage sides against the bulkheads and the bottom sheet. The firewall should be secured with a liberal application of epoxy cement for strength.

The stabilizer, elevator, fin and rudder can be cut from soft ¼" balsa sheet, although it is preferable to use the built up construction shown. The elevator can be installed during fuselage construction, if your work surface is large enough to accommodate it flat against the bottom sheeting. The construction is so designed that the fuselage can be completed including servo mounts, stabilizer, and rudder all in one step.

The wing has no dihedral, and the ribs are flat from the bottom spar to the rear. Therefore, no jig is required and the wing can be completed on any flat work surface. For maximum simplicity, the aileron link-

age is external and holes are cut in the side of the fuselage to allow clearance for the servo as well as the piano wire pushrods to the aileron bellcranks.

On the original, only the wing was covered with silk. On the balance of the wood surface I merely utilized a good dope. The open frame construction of the wing has given no problem with warping, though we have seen some examples of other Ugly Stiks where apparently the builder propped it wrong while the dope was drying, resulting in some rather severe warps. Actually, removing warps from an open frame wing structure of this type is extremely easy. It only requires the use of heat while twisting against the warp to insure a flat wing surface.

Flying of the Ugly Stik is equally as simple as the construction. The design is not overly critical to center of gravity location. It should balance approximately on the main spar or slightly to the rear. No thrust offsets are used.

To sum up, considering the minimum amount of time and effort put into construction, I doubt that we have ever had more fun flying a radio-controlled model aircraft. We believe it is an excellent choice for the beginner and an ideal trainer for multi proportional flying.

Hope you enjoy it!

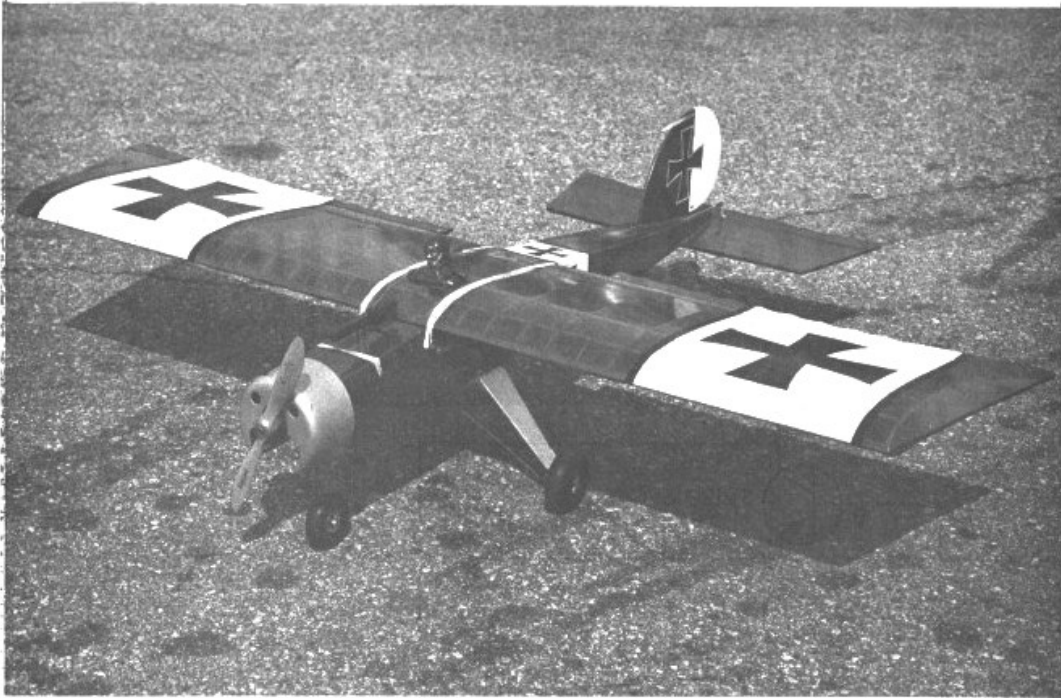

World War I type cowl and wing false ribs embellish Walker's ship. Excellent kit available from producers of Phil's Kwik-Fli kit.

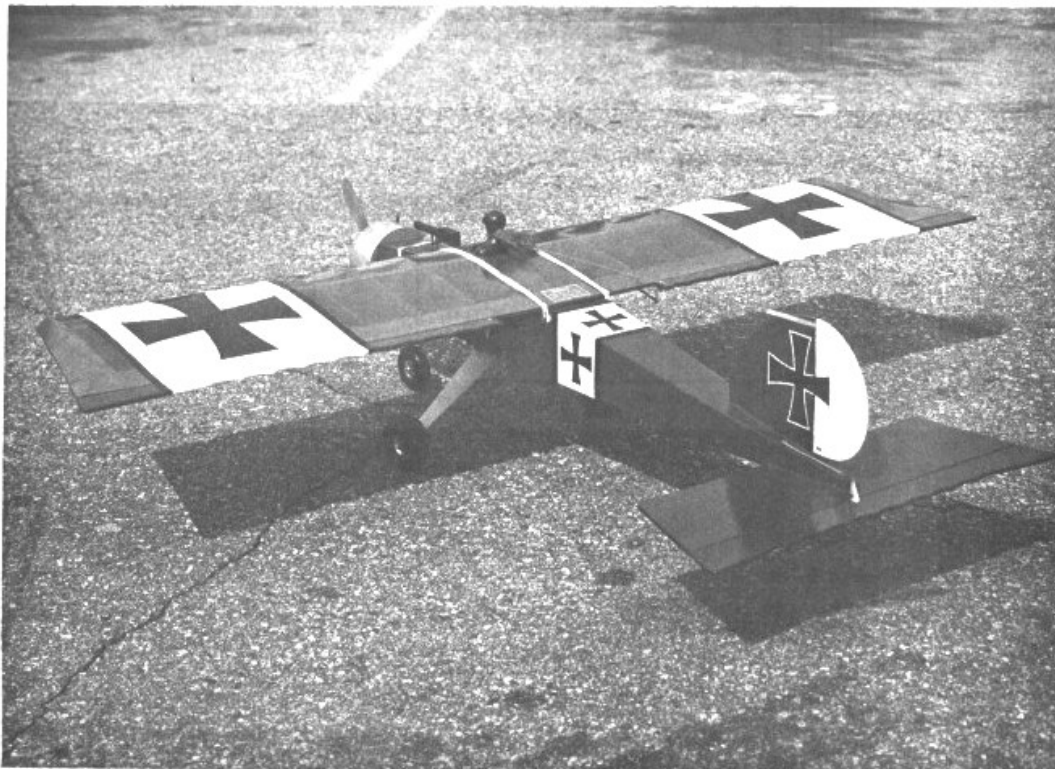

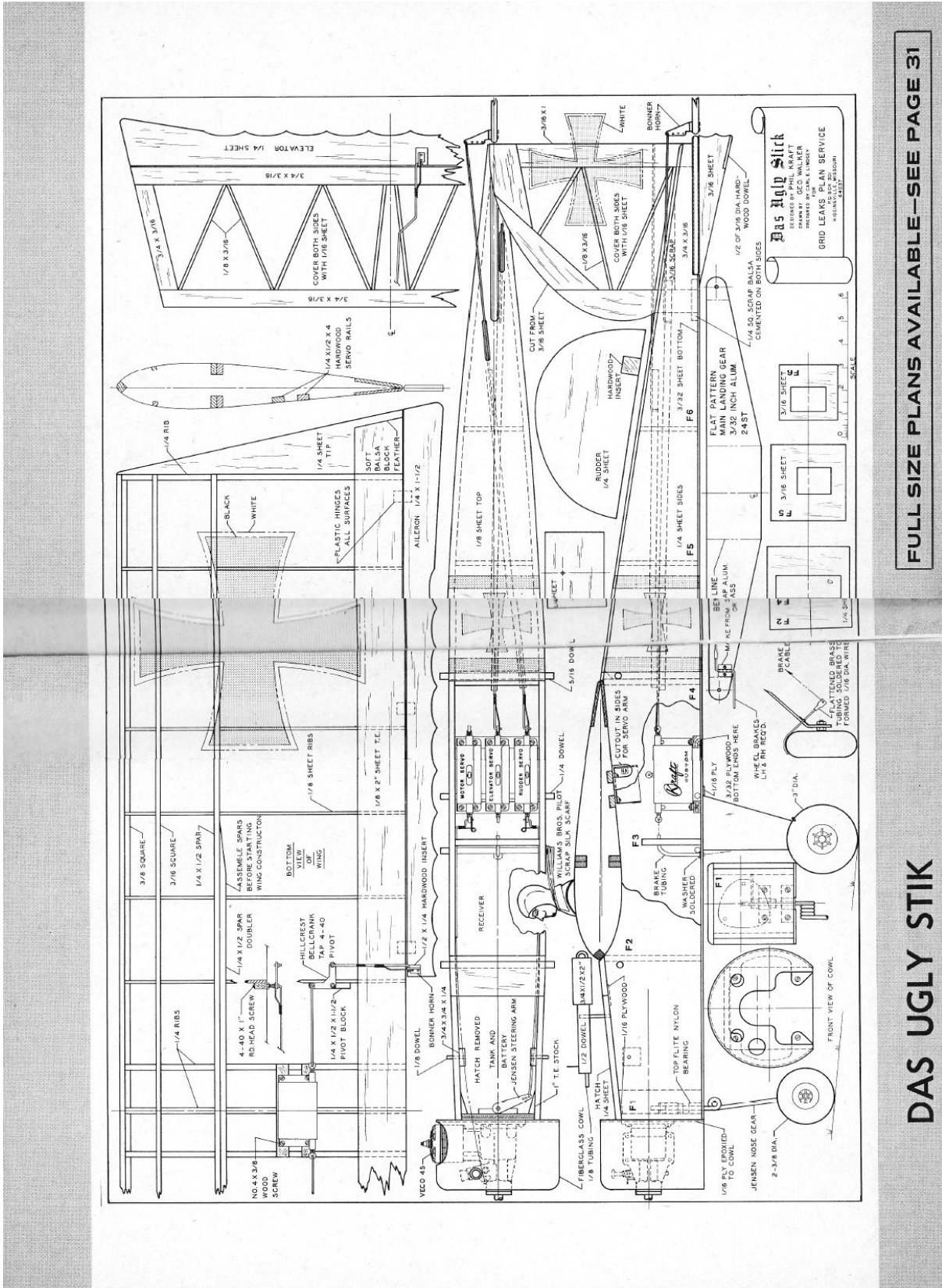

The small plan, spanning pages 8 and 9.

I was amazed how clever *Phil Kraft* was. The straight wing with flat-bottom ribs and also the fuselage are designed for very quick build without a jig. *Phil Kraft* aimed at ultimate simplicity and just therefore got a good flying model. It's yet unbelievable how fast he made the plan and built the model. He was 40 years old then and must have been a very dynamic man. Despite his efficiency, he even cared about some decoration.

That is, he appreciated what *George Walker* did to his original boxy ugly stick. *George* was his friend and his man for such things (all design things, meaning not technical design but design of graphics/appearance). It's amazing that he not only drew and built the engine cowl, pilot and gun, but also a mustache and a scarf for the pilot and the sight of the gun. He drew up the draft that was turned into the plan, built the model shown in the pictures, and posed with it on the magazine's front page.

You might look at the pictures in the article again to identify the two different prototype models. On the green-colored cover picture, as well as on page 5, *George Walker* is posing with his own model, which is shown in two pictures on page 7. It has red fin and white rudder, and a red scarf for the pilot. On pages 4 and 6, *Phil Kraft* is shown with his model (built by *Dick Kidd*), which has an all-white vertical tail and a white scarf. Both prototypes have the more forward vertical tail which has been erased from the vellum plan.

Carl E. Lindsey closely adhered to *George Walker's* original vellum plan, or draft for that matter, when he "prepared" the GRID LEAKS plan. Basically, he rearranged it to make do with a smaller paper format, and he added a separate wing rib outline. He forgot the small wing spars in the fuselage side-view but added a line showing 0.5 degrees wing incidence. And a puzzling detail: He added a hole in the engine cowl, presumably as air intake for the carburetor. All else is exactly the same.

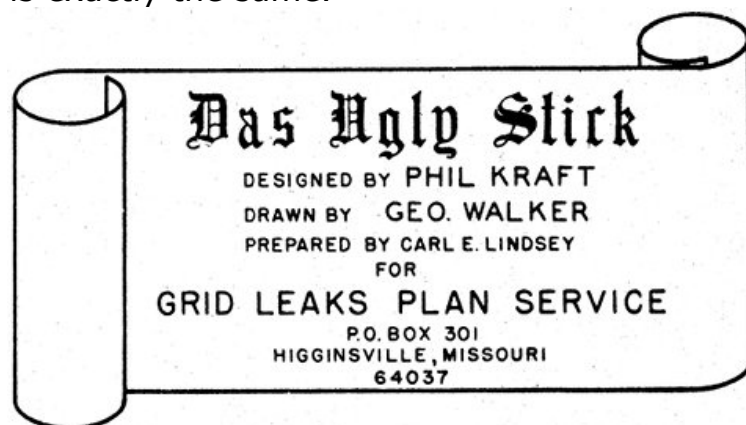

He made even an effort to express the model's character by making the title box look like a strip of paper rolled up on both ends, and by using a "Gothic" font for the model's name. He just overlooked the special spelling "Stik" and wrote "Stick" instead. Both model and plan are not yet as perfect and elegant as the Jensen kit version, which came shortly after.

Jensen Kit

There wasn't really much to improve, yet *Jim Jensen* wanted some modifications for the kit. The plan published in GRID LEAKS was actually a draft for the prototype model. This prototype was kind of a feasibility study, a showcase to carry the idea of a grim German fighter as kind of a macabre Halloween symbol (as I like to put it) to extremes. The model had to be refined and optimized for kit production, and a proper plan with instructions was needed.

At first glance, there are few minor differences between the Jensen kit plan and the original GRID LEAKS plan. Only on closer inspection, several smaller or larger modifications stand out. Why should we, as ordinary modelers, care about such minutiae when we buy a kit just because we don't have to care then. I didn't either until recently when I got to know *George Walker*.

We see the difference between a draft, which is yet perfectly detailed, and a definitive kit plan. The modifications make a difference for a mass-produced kit model. They may help looks, ease of production as well as building, reliability, or practicality. It takes a creative and at the same time meticulous professional like *George Walker* to get a complete plan virtually perfect in every detail (and someone like *Jim Jensen* to produce a virtually perfect kit).

The Jensen kit version adopts the model's overall appearance as well as its construction. The pure "frills" – engine cowl, pilot, and gun – are left out, perhaps because they were seen as a bit too fancy and not really needed for the intended look (or even cumbersome like the cowl). The round vertical tail as well as scalloped ailerons and elevator were retained as important for the WWI fighter look, the "German" paint scheme was rather emphasized. (They had decided for an all-white vertical tail because it looked better.)

Like in the vellum plan, *George Walker* delineated the paint scheme in the kit plan, in the correct places on wing, tail, and fuselage. *Jim Jensen* thought they should have an "American" paint scheme as well, so *George* sketched a livery used on US trainer airplanes (like the PT-19). He put the insignia star on the right wing in the plan (the German cross on the left one), but he had to add a fuselage side detail for the eagle symbol. He had to draw even another vertical tail to depict the blue, red, and white stripes on it.

Jim Jensen built a model for himself, presumably from a pre-production kit, with the "American" livery. It is shown, as an alternative to the "German" liveried model, on the advertising flyer enclosed in the kit. There are diagonal stripes on the wing, which really make for a better look. They are not shown in the plan so they must have been added to this model. I suppose they were red as seen on some full-size airplanes.

Obviously, the "American" paint scheme never caught on, at least I never saw a picture of a model painted like that. On the flyer, it was presented like an appendix, right down at the bottom. On top was the "joke", as *Phil Kraft* had put it in his article, which was the interesting design in the first place:

JENSEN

Das Ugly Stik

designed by PHIL KRAFT

CLASS II & III

WING SPAN 60 in.

WING AREA 720sq in.

FLYING WEIGHT 6 pounds approx

ENGINE 0.45 to 0.61

Great! multi trainer

ideal for the beginner or experienced flier

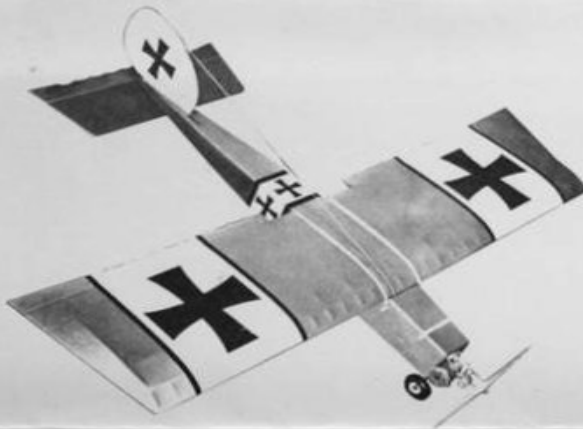

EXTREMELY QUICK and EASY to BUILD

2 ILLUSTRATED FULL SIZE DRAWINGS
(full span wing and fuselage)

SELECT GRADE Balsa

ALL PARTS MACHINE CUT and/or SANDED
to EXACT SIZE and SHAPE

WING KIT
with Full Span Drawing

FUSELAGE - STABILIZER - RUDDER KIT

MAY BE PURCHASED SEPARATELY

KIT INCLUDES ALL HARDWARE

- HEAVY DURAL FORMED MAIN GEAR
- NOSE GEAR
- STEERING ARM
- PUSHRODS & CLEAVISES
- CONTROL HORNS
- BELLCRANKS
- NYLON BEARING BLOCKS
- BRASS & PLASTIC TUBING
- BOLTS, NUTS, ETC.
- *Wheels, Engine, Propeller, Covering not included in Kit*



JENSEN ENTERPRISES, P.O. BOX 122, 408 S. VERMONT AVE., GLENDORA, CA 91740

It was consequential to highlight the appearance of a grim German fighter because that was the whole point of this design, in fact not only the paint scheme but also the shape of wing and tail. The flyer illustrated what didn't come across in the stark plan.



George Walker had not only chosen **Das Ugly Stik** as the model's name, he had even made a special lettering for it by developing the "Gothic" font. It was used in the plan's title box, on the flyer's top, and on the kit box (see below), which has a minimalist box art label with a stylized, typical wing. All that is a consistent, appealing, modern-looking graphic design, just a total work of art that shaped this model's "image". Now let's look at the details:

The fin had been a built-up "truss construction" (like the stabilizer) in the prototype design because it's not that prone to warping when covered and painted. But *Jensen* wanted the simpler sheet balsa solution for the kit. The vertical tail had been set back already in the vellum plan before. The rudder hinge line is now just a bit in front of the elevator hinge line. That made the moment arm longer and accordingly the vertical tail had been made a bit smaller, as well as the German cross on it.

The landing gear was left unchanged except that the hardwood tailskid tip was replaced by a protruding piece of piano wire. Even the wheel brakes (actuated together with down elevator) are drawn in the plan. They were probably built by few modelers even though they might have been useful on the paved airfields they had, like Van Nuys or Whittier Narrows.

The motor mount was left unchanged as well. It seems to have been typical for *Phil Kraft*. It was an aluminum backplate bolted to the engine's back. It had three holes to be bolted to the firewall. In this case the engine was mounted with horizontal cylinder and one of the three mounting screws was used for one of the nose landing gear bearings at the same time.

A more obvious modification has been done to the formers. In the original plan, there are rectangular cutouts. In the *Jensen* plan, there are oblique rounded cutouts and these are in different places. They are provided for rudder and elevator linkages.

An isometric sketch was even added showing how the formers have to be built up on the flat fuselage bottom.

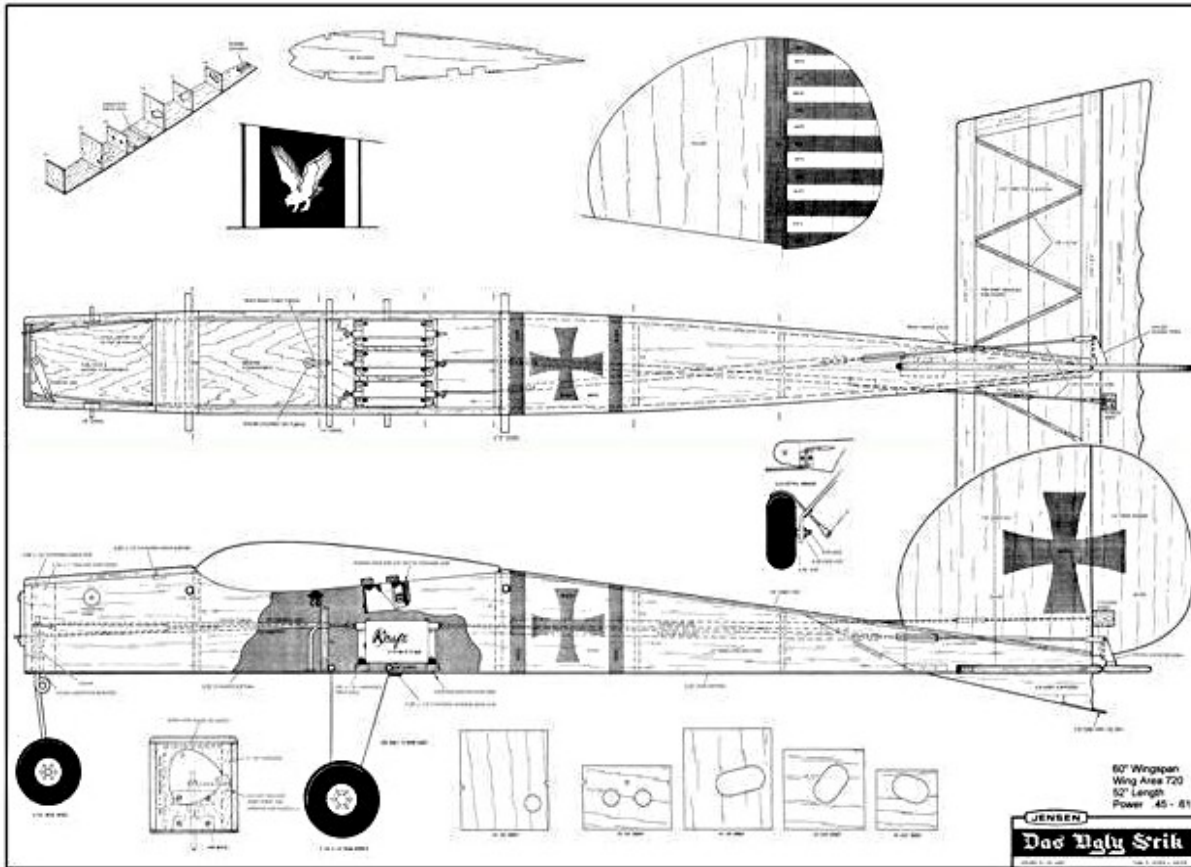

Fuselage sheet of the Jensen kit plans. (Full-size plans at [Outerzone](#).)

Actually subtle modifications were done to the control linkages. While the elevator linkage is cranked and comes off the fuselage top in the original version, it is straight and comes off the fuselage side in the Jensen version. The aileron linkages have 60 degrees bellcranks instead of the original 90 degrees bellcranks.

Whereas the elevator linkage modification is a mere mechanical simplification and improvement (better rigidity), the bellcrank modification even matches the wing dihedral. The latter gives some directional stability, the former some aileron differential eliminating adverse yaw. Both are at the cost of less roll rate and apply only to flying upright and not inverted, but that's just why this combination is very common for trainer models. By the way, even pattern competition models of the 1960s had some dihedral and "semi-symmetrical" (cambered) airfoils.

So perhaps the Jensen version could be seen as an even easier to fly trainer than the original version (GRID LEAKS).

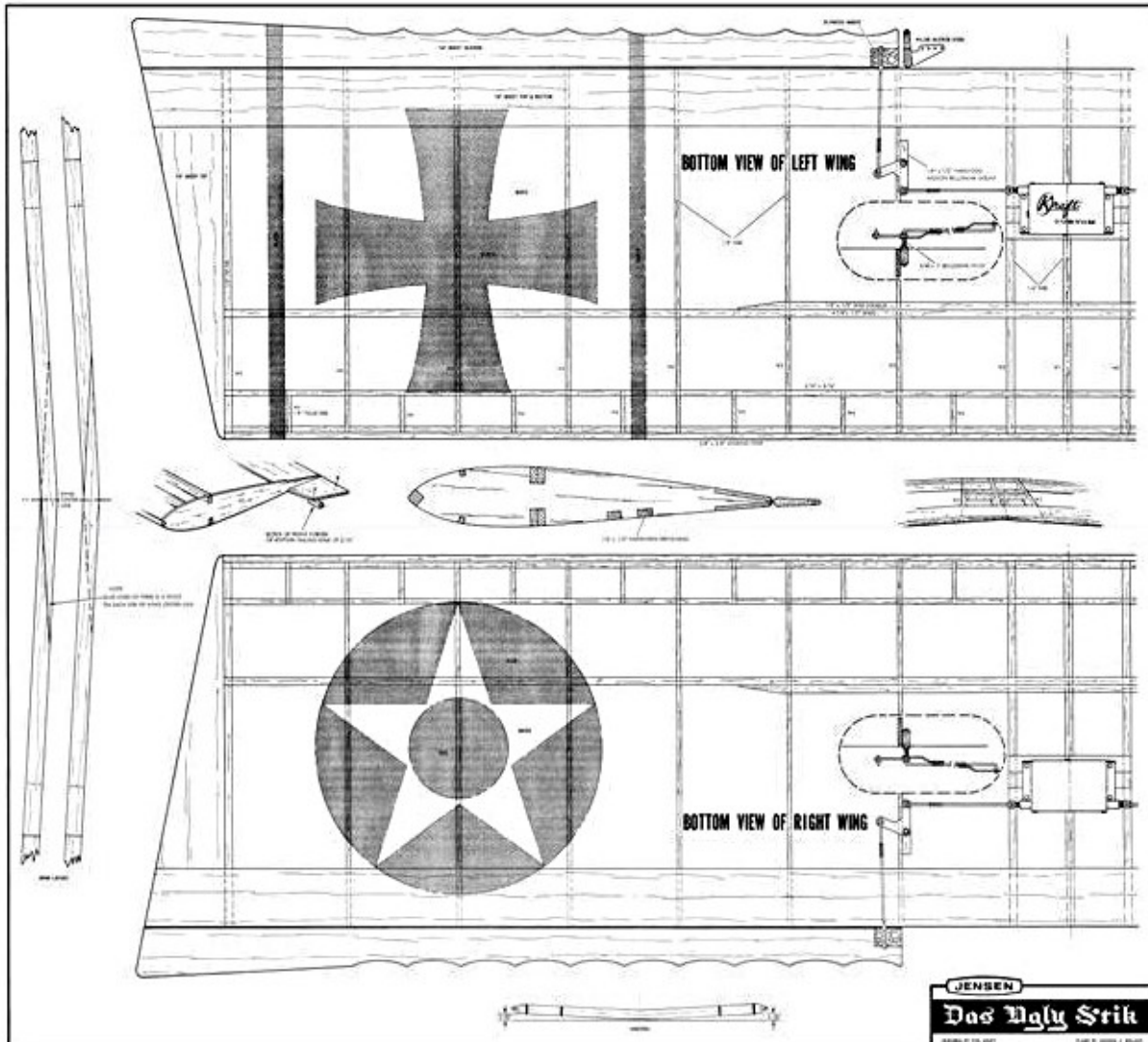

Wing sheet of the Jensen kit plans. The instructions on the left margin have been cropped.

The most striking modification was adding dihedral to the wing. This was done to improve the model's looks by avoiding the impression of anhedral (drooping or "lame" wings).

Detail sketches on the wing plan outline the wing spar scarf joints, flattening the center section, and the right amount of dihedral. A wingtip detail and a rib profile are added for completeness. Perhaps most important were the instructions on the left margin of the wing sheet (cropped here).

That was all perfect when it came out. Later, when film covering (Monokote) caught on, the wing turned out to be a bit too weak. They just added a few pieces of plywood webbing to the kit (see this [post](#) at RC Universe) as well as a note about installing them. The note also describes the slop-free aileron bell-crank installation in more detail.

Just to give an impression, here are two pictures of the kit, borrowed from an offer in the Classifieds section of RC Groups ([here](#)):



The label including lettering had been designed by *George Walker*. He told me that *Jensen* didn't die-cut the balsa parts but sawed and sanded them to exact shape. Die-crush, as it was also snidely called for often blunt tools, was not good enough. Below you see the flyer and the note mentioned above, lying on top in the kit box. Underneath are plan sheets and the wooden parts as well as all necessary hardware. Must have been very high quality.



RCM Article

The two-part Radio Control Modeler (RCM) magazine article was in the May and June 1985 issues. That is exactly 19 years after the GRID LEAKS article. That "has survived for 10 years" in the article's subtitle (see following page) could be a typo, 0 instead of 9. Anyway, after giving credit to *Phil Kraft* and reproducing the text of the GRID LEAKS article (which is short enough), except the paragraphs about construction, "RCM staff" writes:

» ... We are presenting the version of the Ugly Stik that was originally kitted by Jim Jensen. We have incorporated a few updates such as using a plastic engine mount and a modern radio system. ... Also, in response to numerous reader requests, we are presenting a most comprehensive set of building instructions and photos. ... «

So obviously they responded to requests of readers who still wanted to build the very popular Jensen version, despite the emergence of numerous Stik "offsprings" until then. They not just reproduced the plan but updated it in the sense of using modern equipment. They added illustrated building instructions for the model builders of the 1980s who demanded such, while the 1960s builders had to go by with the short instructions on the Jensen plans.

Accordingly, the plans' title box is modified. While the Jensen kit plans said "Designed by Phil Kraft – Plans by George A. Walker", the new RCM plans say "Designed by Phil Kraft – Plans by Bob Wallace". They replaced *Jensen's* plain logo with their flamboyant emblem and *George Walker's* pithy name lettering with a pleasing one, not really matching the model's traditional character:

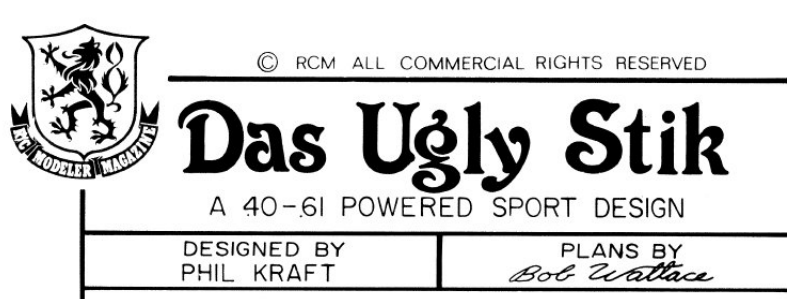

Just compare the RCM plans on the following pages to the Jensen plans above to see yourself what has been modified (full-size plans as well as article at [Outerzone](#)). It's not much, just a due update, but not the reason for this comprehensive, even two-part article.

There had been instructions on the Jensen kit plan, just short and without illustrations. There had been an isometric sketch of the fuselage build-up, three sketches illustrating the wing spar joint and dihedral, and a detail sketch of the wing tip. That had sufficed, but obviously 19 years later it didn't any longer. Now it was all about detailed instructions and even photos illustrating each construction stage.

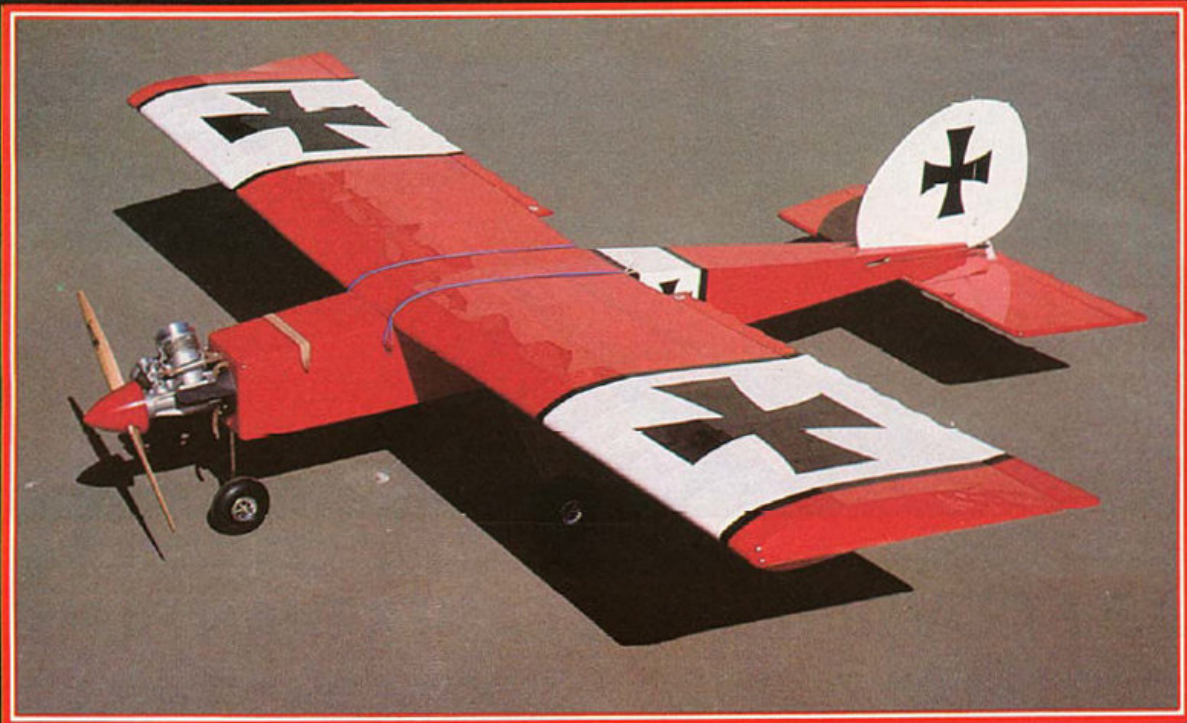

DAS UGLY STIK

A classic design that has survived for 10 years.

By RCM Staff

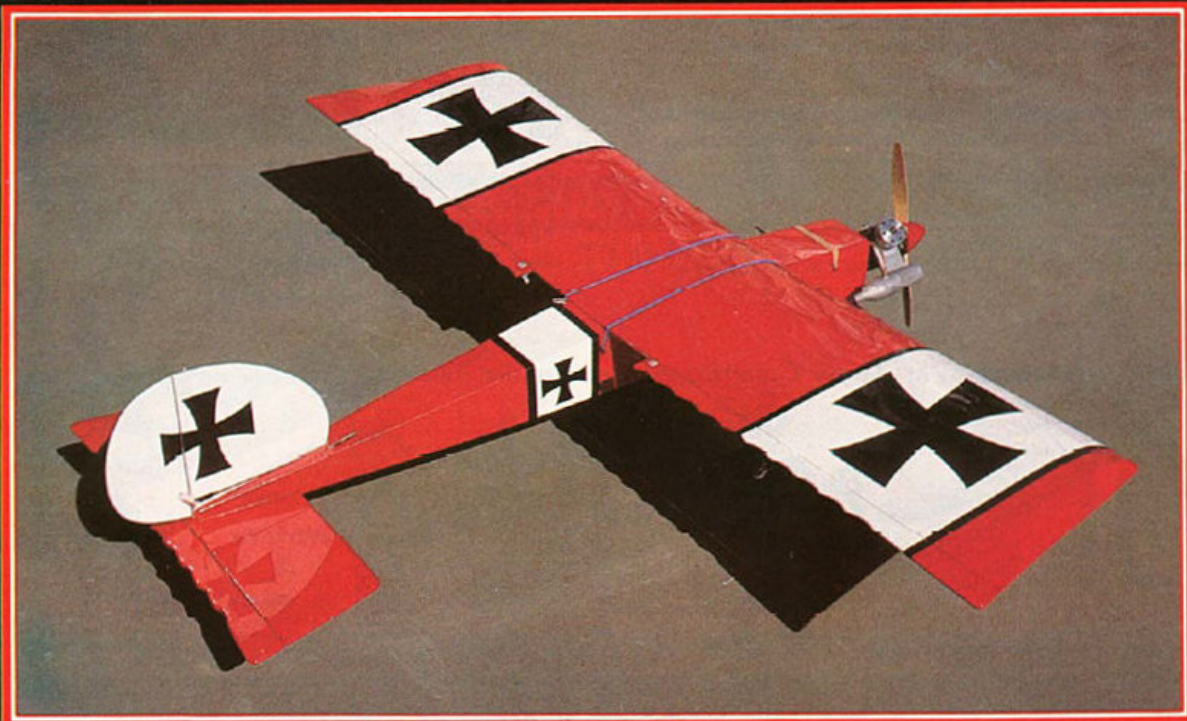

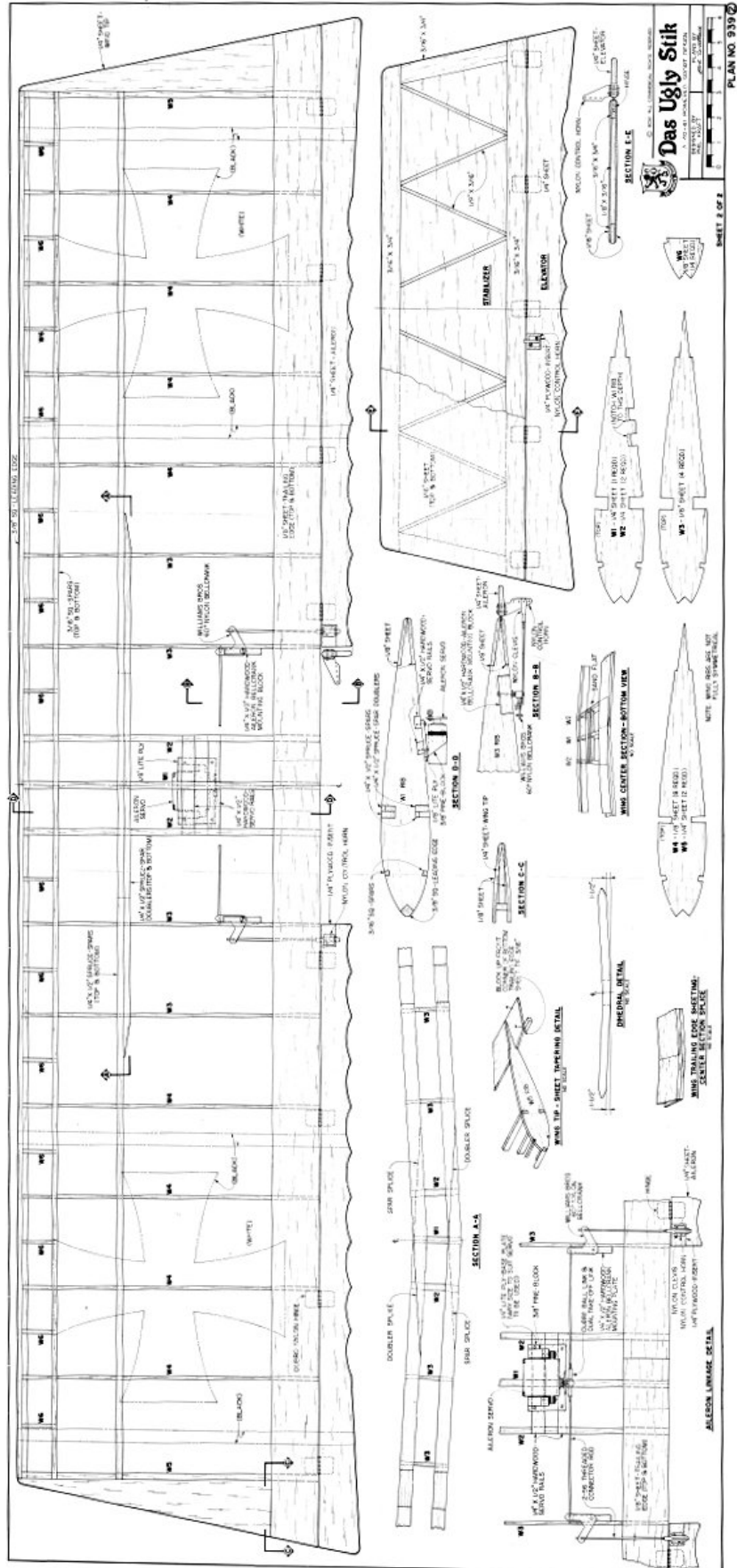

Bits and Pieces

Things that have to do with Das Ugly Stik in the widest sense, interesting or curious, in no specific order:

Just in 1966, the cartoon film "It's The Great Pumpkin, Charlie Brown" (see [Wikipedia](#)) came out as one of the "Peanuts" series, which is cult till today. Characteristically, one strand in this Halloween episode is about Snoopy as WWI flying ace trying to find and shoot down the Red Baron (see scene at [YouTube](#)). So at least it is not absurd to see a connection between Halloween and Das Ugly Stik.



Snapshot from the cartoon film "It's The Great Pumpkin, Charlie Brown". You'll see brown goggles, green cap, and red scarf in the next picture as well.

There's even another association, again just from 1966. A song by a band called "The Royal Guardsmen" (see at [YouTube](#)) referred to the cartoon film with Snoopy as WWI flying ace and the Red Baron as his adversary. They even turned it into a Christmas song (see at [YouTube](#)).

Today, there's a "STICK brotherhood" at RC Universe, and in the founding thread [someone mentions](#) that sometimes people feel upset by the "German symbols" in the characteristic paint scheme of Das Ugly Stik.

George Walker was not influenced by the cartoon film or the song, they came out only later that year. The Red Baron theme just must have been in the air in the mid-1960s. *George* did have some issues of Profile Publications (they are in the [RCLibrary](#)), though, for instance about the Albatros biplane (in the [RCLibrary](#)) and the Fokker Eindecker (in the [RCLibrary](#)).

Above I told that *George Walker* still has two things from his Das Ugly Stik prototype – engine cowl and pilot bust. He made a picture of both so you have the look, even if not feel, of the real thing:



The pilot seems to be the Williams Brothers “standard pilot kit” [still available today](#). Still they have to be painted, and this one got even a mustache painted on and has a remainder of the red-silk scarf on his neck.

By the way, the gun had been made from a piece of wood, a dowel, and some tubing and wire. *George Walker* remembers that the Williams Brothers machine gun kits ([still available today](#)) had been brought out only shortly after the Stik prototypes had been built. The Parabellum or even better the Spandau type gun would have been right for a Fokker Eindecker.

The engine cowl has two holes in its front, for a screwdriver to turn the mounting bolts behind them on the backplate. The GRID LEAKS plan – but not the vellum plan – shows a third hole “below” the right one (left in the picture above), I think as an air intake for the carburetor behind it. Seems to have been an even later idea than the vertical tail set back.

The May 1968 RCM issue ([RCLibrary](#)) introduced Das Liddle Stik by *Larry Leonard*, even on the front page. They made it a fun event, suitable for a fun model. It's a downright witty article in the issue (plan/article [at Outerzone](#)).



Designer *Larry Leonard* and five other members of the local (San Fernando?) Valley Flyers R/C Club built their own model each, all with different paint schemes, two of them rather true to the two Jensen kit paint schemes.

On the front page, four of these builders present their models, three of them duly showing their Kraft transmitters as well. The only non-Kraft transmitter (obviously red anodized case) is bashfully hidden behind the red wing.

Of course, this was a Kraft promotion. The idea was to have a downsized model employing the smaller airborne R/C equipment (receiver, servos) newly brought out by Kraft. They just sold it as an outright fun model, which is cheaper and easier to transport than Das Ugly Stik and even more fun.

They sized it to 0.75 the original's size, for .19 to .35 or even .56 engines. *Phil Kraft* then sized his Flea Fli to 0.66 the size of Kwik-Fli Mk. III (later to about 0.75 as well), for mere .19 to .23 engines. Both models are advertised on a full page (#11) in the February 1969 RCM issue (in the [RCLibrary](#)) as "coming soon" or "soon to be produced in kit form" by Midwest Products.

iss dis "Das Little Stik"?
Ja, dis iss "Das Little Stik"!

MULTI-CHANNEL TRAINER KIT N^o 122

Fast to build
Easy to fly



Wing Span 46 ins.
Wing Area 414 sq. ins.
Engines .19 to .35

LOOK at what the EXPERTS say about "Das Little Stik"!

<p>"Only Kraft would fly a thing like that!" Cliff Weirick</p> <p>"Midwest must be out of their tree!" Bill Winter</p> <p>"This could set modeling back 50 years!" Walt Schroder</p>	<p>"***** (censored) ** *!" Frank Garcher</p> <p>"I wouldn't be caught dead on the flying field with that monster!" Don Dewey</p> <p>"Vas iss los?" Jim Grier</p>
--	---

sure it's ugly, but it's designed for flying, not for looks



400 S. INDIANA ST. HOBART, IND. 46342

Again, the announcement of Das Liddle Stik is made exertedly funny, and that's why it's shown here. Remarkably, the May 1968 RCM article had mentioned the Jensen kit, but now in February 1969, both models are announced by Midwest Products, which later produced the Sweet Stik. *Frank Garcher*, mentioned in the ad, was president of Midwest Products.

“Windy” Kreulen and predecessor to Das Liddle Stik, also inspired by Kraft’s Das Ugly Schtik. Ueda .19, M. K. Custom digital (Japan). Ship very light and maneuverable. Windy, active flier and model merchant in Holland.



65

In the February 1969 RCM issue (in the [RCLibrary](#)), far behind at page 65, is also a notice about an Ugly Stik offspring, correctly stated. Note funny spelling of the model’s name.

This is a distant Stik offspring, in the sense that it's a German design and different in several details, though not in the general concept. It had been brought out not later than 1969 by *Wilfried Klinger*, an engineer well-known for several successful designs as well as his own small model business (WiK).

From his 1969 catalog: » Jonny is a full-house ship that is built in a few hours and that hides its simple construction behind the oldtimer look. « It was meant as a docile trainer (with .30 to .45 engines) or as a fun flier and air-show stunter (with a .60 engine). In fact it was popular with quite a few model fliers in Germany and abroad, and it's sometimes sought-after even today.

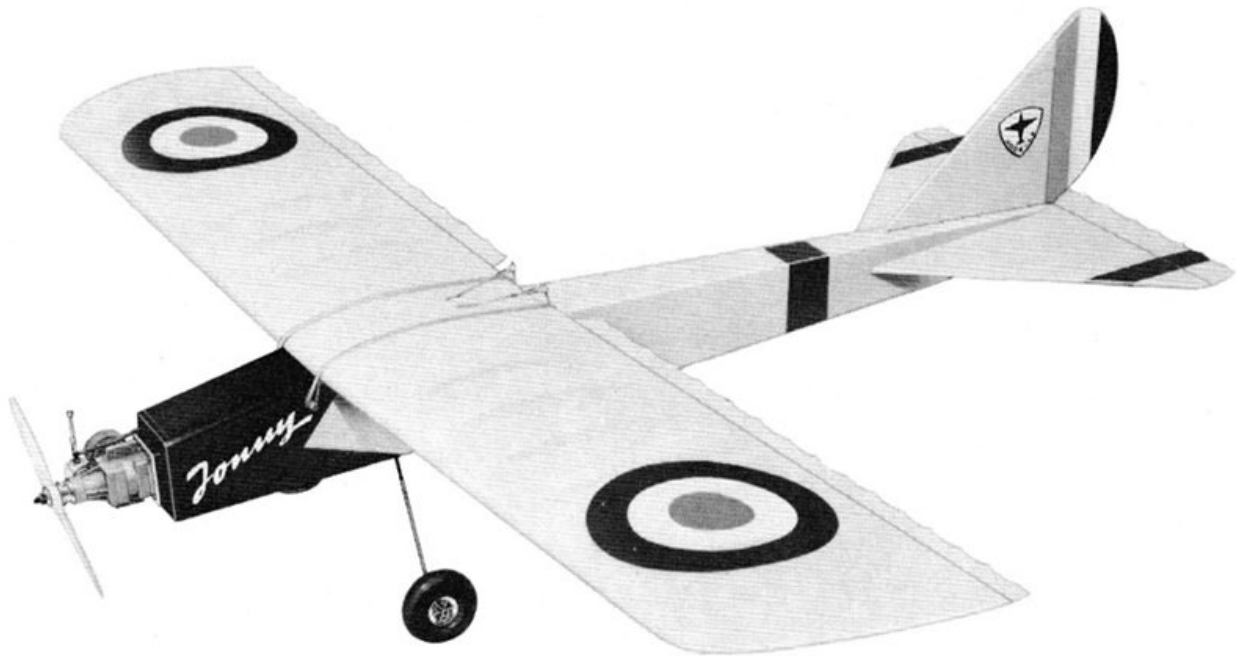

Wing span was 59 in, weight about 5½ lbs. (See plan and comments [at Outerzone](#).) The fuselage is Stik-like, the engine rear-mount is, as is the wing planform with scalloped ailerons. The paint scheme and the tail shape are French, as it were, but the catalog points out that a Fokker- or Albatros-style tail may be built without changing the flight behavior. Lo and behold!

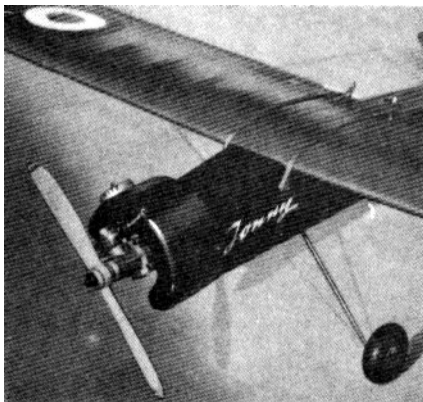

There was even an ABS plastic cowl "for a more interesting look" (catalog). There was an engine mount with steerable nose landing gear, in case a tricycle landing gear was preferred. Original 3" Du-Bro wheels were an option. Nylon fabric and dope covering; silk was too expensive.

The kit cost 69.50 DM in 1969, not even half as much as a pattern competition model. And due to the 4 DM to 1 \$ exchange rate, that would have been only 17.38 \$ in the US.



A "very patriotic Ugly Stik" just as an eye-catcher on April 1971 RCM's cover.

Inside this issue (available in the [RCLibrary](#)): »The Frantique Too . . . one of the finest sport aircraft ever presented by RCM«, designed by *J. Harmon*.

The article's abstract reads: »For .19 to .30 power, the F-2 is truly an outstanding machine. The prototype in the photos, built by Don Dewey, served as RCM's test bed for the Graupner-O.S. Wankel engine. At 500 sq. in., it's docile on a .19 . . . fantastic with a .30.« Well, well, well, a Stik for a Wankel! Seems to be a natural combination. So far so good and interesting.

The text begins witty: »The "FRANTIQUE TOO" was designed and engineered by the infamous and somewhat old-fashioned "Baron Von Drafty-bottom," with all the hard and dirty work done by his faithful helper, Assistant Second Grade J. Harmon.« And it goes on in this style: »Well the old codger looks like he's done it again. ... Let me tell you the "Baron" is a NUT to say the least. ... After spending a week in his favorite Kneipe he came staggering in with some childish looking scribblings and calculations on the back of an old Haufbrau label.«

Enough allusions to the old "joke" to put us in the picture, to set our mood. We're amused and expect something familiar, something we're appreciating and that evokes memories of having fun. Here is this funnily ugly thing:

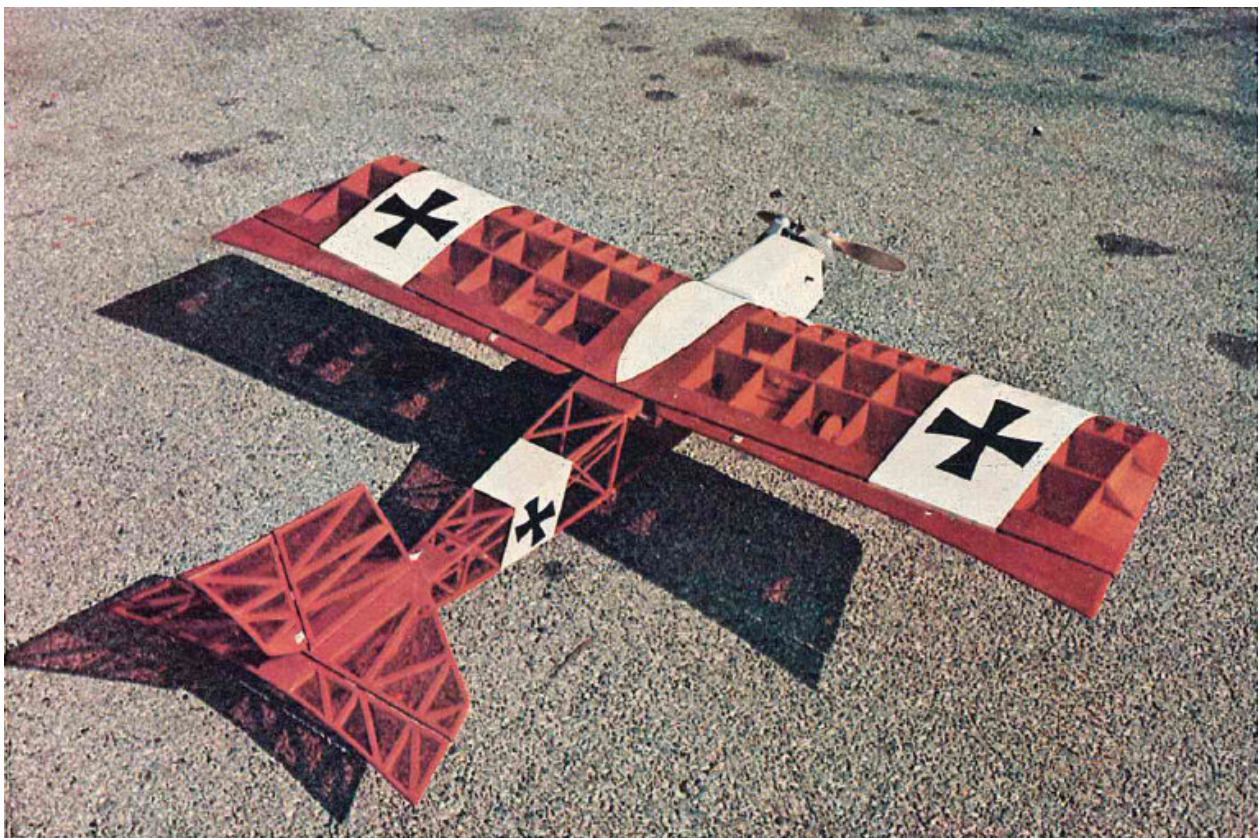

Not to be a kill-joy, I would have expected some reference to Das Ugly Stik, though. With that shape, the red color, and the German crosses, the model just can't disclaim its provenance. But nothing. Obviously, five years after its publication, the Ugly Stik design has finally become common property.

Now, for a change, an ordinary Stik but an extraordinary pilot: five year old Chip Hyde at the 1977 US Nationals – noncompetitive but competent.

From November 1977 Model Aviation: » Star of Sunday air show was 5-year old Chip Hyde of Yuma, Arizona, who flew RC Ugly Stik unassisted except for advice from his proud dad. The crowd loved it. Chip has been flying RC for the past year. «

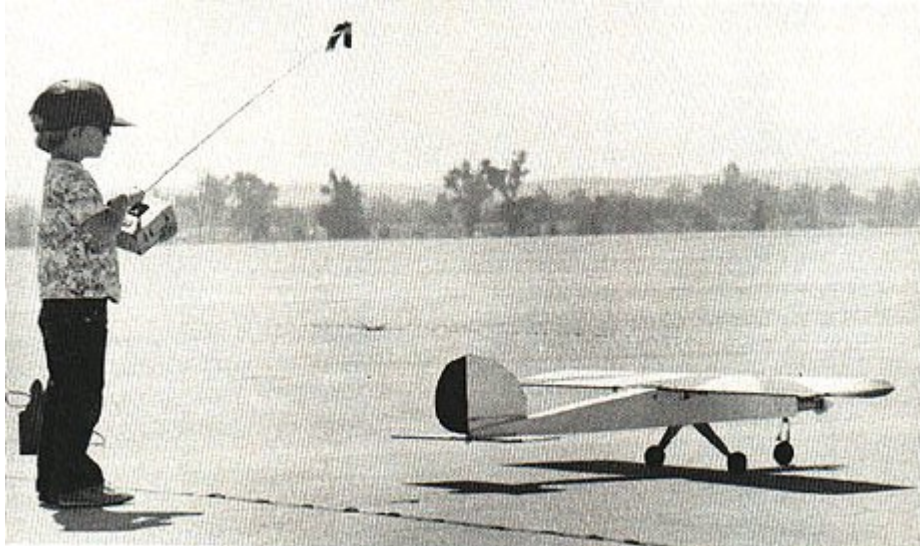

This was mentioned in a discussion about the “History of Classic Pattern” at RC Universe (posts [#10](#) and [#41](#)) and also at [RC Groups](#).

Notice the straight wing (without dihedral), looking like it’s drooping. Also notice the single-stick transmitter!

The following drawing shows a typical R/C installation in the Ugly Stik. It is from a time when servos already had rotary actuators and the Ugly Stik was very popular. Just an interesting aside...

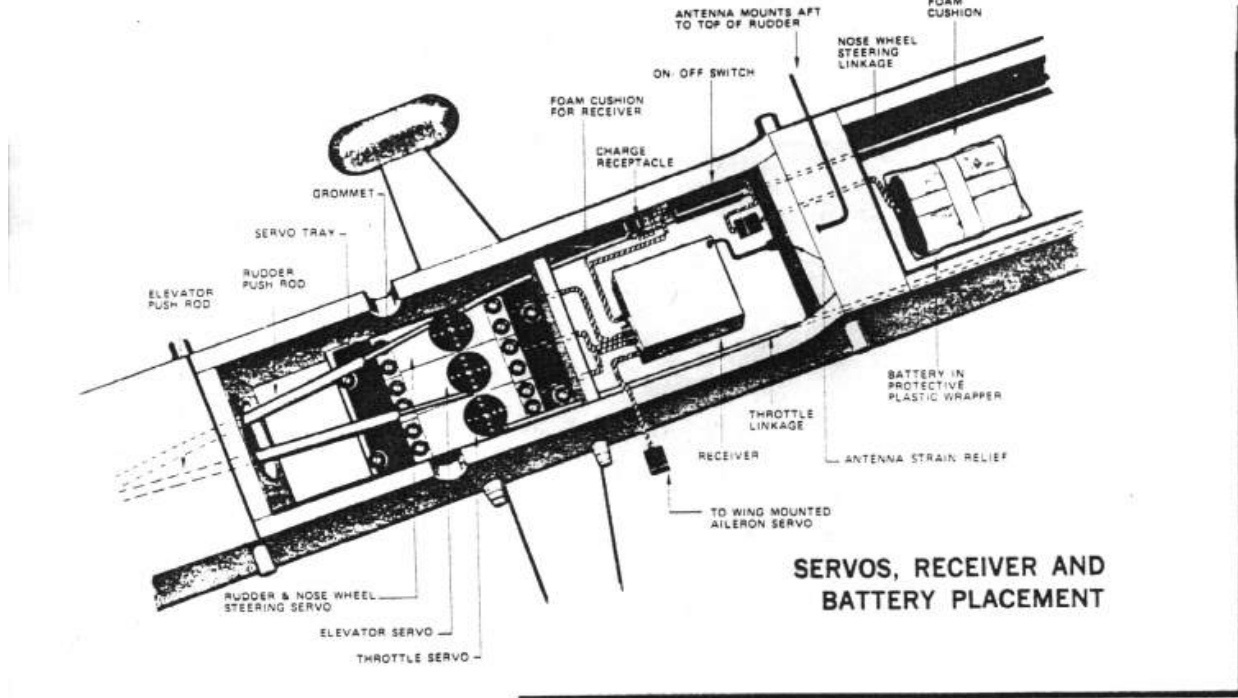

TYPICAL R/C INSTALLATION

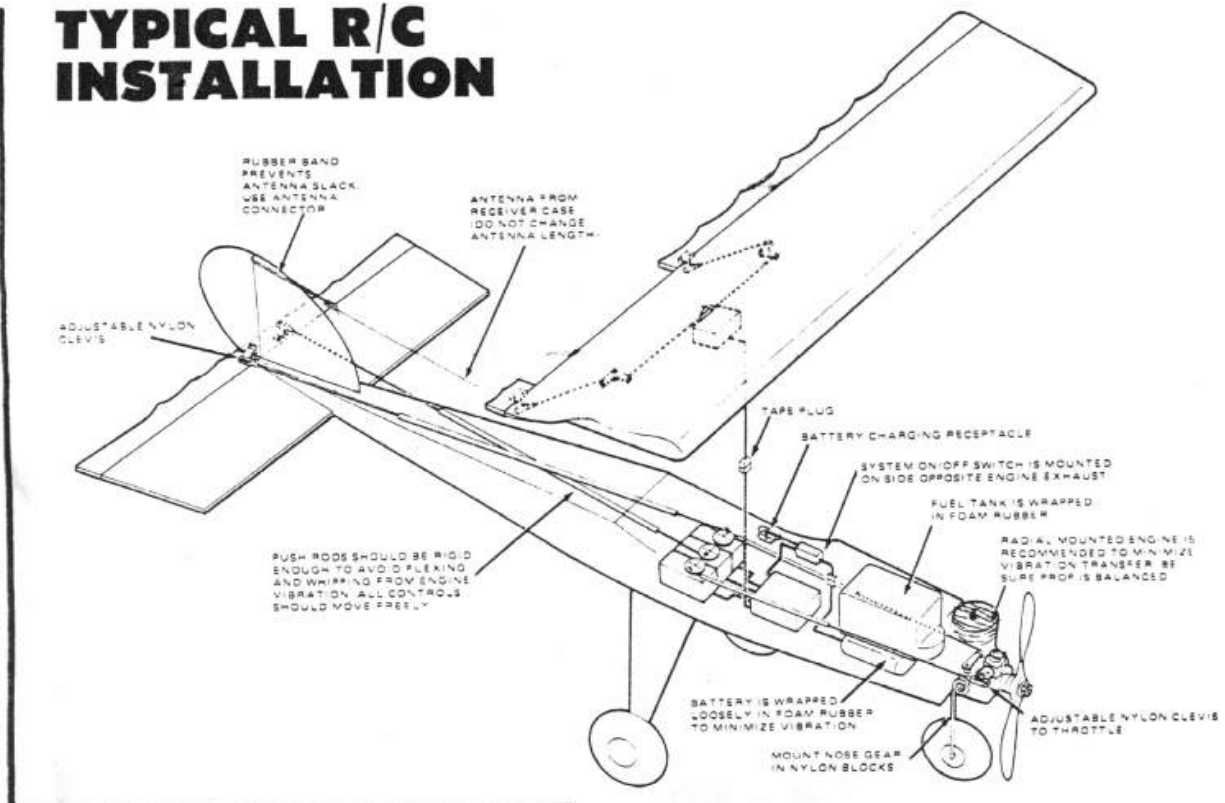

Finally I have to mention the model that was the starting point of my whole Ugly Stik mania and actually led to this paper, so we come full circle now:



Unmistakably, it's a Stik offspring even though from the year 2002. It's typical both as a Stik and for its time. The new category of parkflyers made our hobby more affordable and practicable than before. Characteristic were a small model size owing to lightweight R/C components, and an electric drive with one of the inexpensive 400-size can motors and a NiCd battery. Outrunner motors and LiPo batteries came a bit later (picture above from 2005) and were still expensive.

Characteristic were also conventional balsa construction (just film covered) but selling ARFs instead of kits. Foam construction and BNF came again later. The models were made in the Czech Republic for quite a few years as long as their manufacturing costs were low and China was still not an option. Yet they had to be simple and easy to build in order to keep costs low.

This one was meant as an aerobatic parkflyer so the simple Ugly Stik design was a natural choice. Another novelty of the time was 3D flying, but that was actually not possible with a cheap parkflyer in general and with a Stik-type model in particular. The name *threedee*⁴⁰⁰ (for 3D flying and 400 motor) was an oxymoron and just a necessary marketing ploy used by the companies selling the model (back then Hobby-Lobby International in the USA and Scorpio in Europe).

The 2002 review [at RC Groups](#) made that implicitly clear by mentioning only conventional pattern maneuvers. But it made explicitly and perfectly clear that this model is a very good conventional aerobatic trainer without any bad habits – just a Stik. I can affirm that, it's why I bought this model in the first place and why I still like and fly it. It's just a curiosity today, only 15 years later. On the flying field it raises amazement: Oh, is that nice! Oh, it's made from wood! Oh, it flies really well! Oh, you can really knock it around without hesitation! Oh, it's not 3D capable? Definitely yes and no – it's just a Stik.

Even years ago, *Ed Moorman* stated ([on his old web page](#)): » The trouble with recommending a Stik is they have no pizzazz and most have gone out of production. « Then again, there are still some Stik models in production, some in wood construction and some as foamies, some with modern paint schemes and some in the traditional livery now called "retro". So still some modelers buy them, and still some modelers build them, whether with wood or with foam board, which lends itself to the Stik design. (For instance, look [here](#), [here](#), or [here](#). The latter made my article – this paper – popular in the Web and eventually led to me getting to know *George Walker*.)

Some or even most of these builders did it explicitly in honor of the original design and referred to the GRID LEAKS article and plan. Some of them applied their own fancy paint schemes and some others the "traditional" one. All of them modified several details to their own fancy but built the characteristic shape and not the "square" or "boxy" shape.

That is the lasting achievement of *Phil Kraft* with his sense of simplicity and efficiency, and of *George Walker* with his talent as a graphics designer. They just knew what works and looks best, or rather they knew how to find out. So thank you *Phil Kraft* and *George Walker* for designing and embellishing the Stik as we know it and for making it popular! It is with us for more than five decades now.

Long live Das Ugly Stik!

Sources

Eric D. Wildermuth from Brisbane, Australia, kindly provided the scanned images of his copy of the GRID LEAKS magazine and valuable information from his rich experience building and flying several Ugly Stiks. Later he even found the advertisement mentioning Ugly Stik's derivation from a "Square Stik". Thank you very much!

Some members of the Vintage R/C Society scanned all old GRID LEAKS issues and put them on the Web. See [here](#) for volume 7 number 3 to find the Ugly Stik article with plan. It was also shown without plan in an [Ugly Stik thread](#) on RC Universe. The full-size GRID LEAKS plan as well as *George Walker's* autographed original vellum are on www.outerzone.co.uk as scanned PDFs.

George Walker's Early Sixties R/C 8mm movies, especially the Das Ugly Stik prototype maiden flight, are in a playlist at [YouTube](#).

The Jensen kit's flyer and plans were borrowed from one of "Uncle Willie's" now extinct websites. Later, the flyer as well as the whole kit have been shown in an offer in the Classifieds section of RC Groups ([here](#)).

The building instructions on the left margin of the wing plan were lost, but you could find them in the complete (tiled) plan in [this post](#) in the Ugly Stik thread at RC Universe. The original Jensen kit plans (autographed by *George Walker*) are now on www.outerzone.co.uk as scanned PDF.

The 1985 RCM article was available without plans in a [Blog](#). The RCM plans along with the article are now on www.outerzone.co.uk as scanned PDFs.

The R/C installation plan was shown in a [thread on RC Groups](#).